

2025 / 26 / 27

# Strong Hand Tools

The Big Book of Efficient Workholding for Welding & Fabrication.

**Welding Clamps & Pliers**

**Magnetic Squares**

**Fixture Vises**

**Grounding Tools**

**Shop Equipment and Organization**

**StrongHandTools®**

StrongHandTools.com 562.949.8625

**Metric**



**We create metalworking products that save time, increase comfort, and improved quality for our customers.**



Quick Acting Welding Tools  
[www.StrongHandTools.com](http://www.StrongHandTools.com)



Mobile Fixturing Station  
[www.Rhino-Cart.com](http://www.Rhino-Cart.com)



Modular Welding Tables  
[www.BuildProTables.com](http://www.BuildProTables.com)



Heavy Duty Welding Tables  
[www.Alpha28Tables.com](http://www.Alpha28Tables.com)



Toggle Clamps & Latches  
[www.GoodHandinc.com](http://www.GoodHandinc.com)



Operating Accessories & Tooling Components  
[www.Valtrainc.com](http://www.Valtrainc.com)

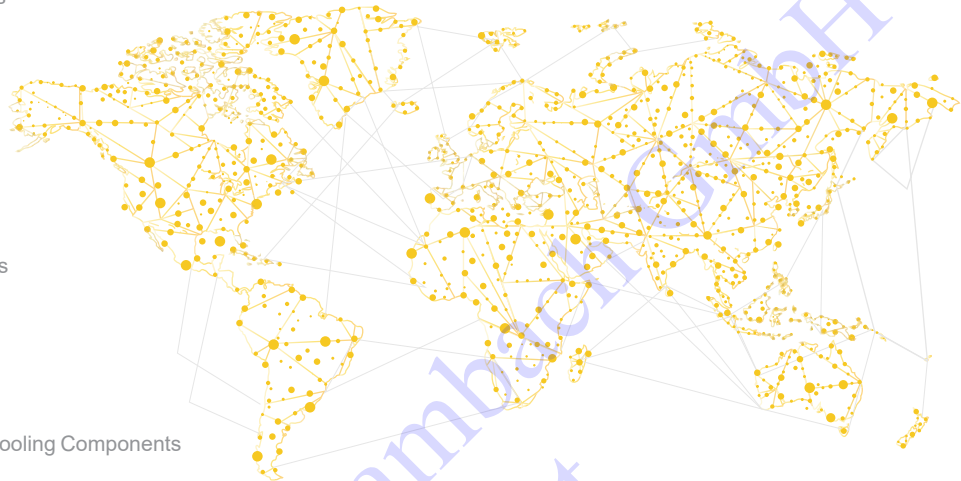

The Strong Hand Tools® line of innovative products are sold in over 60 countries worldwide, through a network of Authorized Distributors delivering timely technical and customer service support for your business.



USA Headquarters in Los Angeles, CA.

For over 40 years, we've communicated with welders and fabricators to develop innovative clamping and fixturing tools. Our dedicated team of engineers continue to study every aspect of layout, clamping, and positioning with a variety of materials so you'll be well prepared to create set-ups for any project. Having the right tools in your shop to handle each new project is the key to improving work quality and productivity, and growing your business.



Product development starts here with rigorous testing from our R & D Team.

You can purchase our products through an extensive global distribution network. Please go to [www.stronghandtools.com/distributors](http://www.stronghandtools.com/distributors) or simply scan the QR code to find all of our authorized distributors near you.



Find Distributors



European sales & distribution office located in Czechia.

# TOOL DIRECTORY

## CLAMPING TOOLS

- 4 4-IN-1™ F-Clamps
- 8 J-Clamp Step-Over
- 8 Ratchet Action Clamps
- 8 MagSpring™ Clamps
- 9 Clamps Replacements & Accessories
- 21 C-Clamp Locking Pliers
- 21 Multi-Purpose Pliers



- 21 Adjustable/Long Reach Pliers
- 22 Big Mouth Pliers
- 22 C-Jaw Pliers with Hammer Head
- 23 Expand-O™ Pliers
- 23 Locking Chain Pliers
- 24 JointMaster™
- 26 Pliers Replacement & Accessories

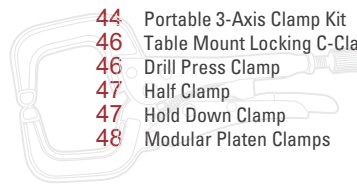

- 44 Portable 3-Axis Clamp Kit
- 46 Table Mount Locking C-Clamps
- 46 Drill Press Clamp
- 47 Half Clamp
- 47 Hold Down Clamp
- 48 Modular Platen Clamps

## MAGNETIC TOOLS

- 10 Adjust-O™ Magnet Squares
- 10 A-Frame HD Magnet
- 11 Adjust-O™ 90° Dual Switch
- 11 Adjust-O™ Angle Magnet
- 12 Inside/Outside Magnets
- 12 Corner Magnets
- 13 Standard Magnet Squares
- 13 Mini Magnet Squares
- 17 Magnetic Alignment Pin



## VICES

- 27 2 and 3-Axis Vises
- 28 Welder Universal Vise
- 29 Aluminum 90° Tru-AngL Jig
- 29 Portable MagVise™



## GROUNDING

- 30 PowerBase™ Grounding Magnets
- 30 Grounding Clamp
- 30 Ground Hog™ Pliers
- 31 Big Mouth Grounding Pliers
- 31 Ground Hog™ Replacements
- 32 Multi-Angle Grounding Magnets
- 32 Magnetic Grounding Grasshopper



## PIPE HANDLING

- 15 V-Pad Kits
- 16 Pipe Alignment Clamps
- 16 Pipe Fit-Up Clamps
- 17 "The Spider" Internal Pipe Fit-Up Clamps
- 18 Adjustable Pliers with Spring
- 18 Extractor - Screw Pliers
- 18 Extractor Locking Pliers

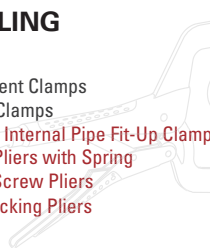

- 19 Large Diameter Pipe Pliers
- 19 Pipe Pliers
- 20 Small Diameter Pipe Pliers
- 20 Pipe Joining Pliers
- 20 Center Jig Pliers
- 22 Economy Pipe Pliers

## LEVELS

- 42 EZ-view 3-axis level
- 42 Mag-Level
- 42 EZ View Conduit Level

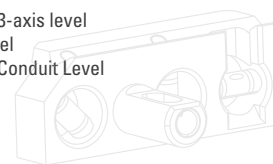

## SPECIAL TOOLS

- 14 MagTabs
- 33 GrassHoppers
- 33 Hole Plug Magnets
- 34 Arm & Wrist Rests
- 35 Grinder Rests
- 36 MIG Torch Rests & MIG Pliers
- 37 TIG Torch Rests



- 37 Table Edge TIG Torch Rests
- 37 Universal Rests
- 38 TIG Feeders
- 38 TIG Part Organizer
- 39 TIG Feeder Stand w/ Magnetic Base
- 39 Magnetic Panel Holder
- 40 Chisels

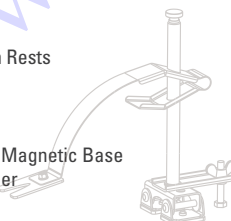

- 41 Sheet Metal Magnets
- 41 Large Magnetic V-Pads
- 43 Leaf Spring Clamps
- 43 Magnetic Welding Gauge
- 44 The Third Hand Modular Clamps
- 45 MagHold™ Extendable Arm
- 45 Snake Magnets

## SHOP TOOLS

- 49 Tool Pouches
- 50 Round Contour Marker
- 50 Round Hole Marker
- 50 Magnetic Pipe Centering Head
- 51 TIG Tungsten Stick-out Gauge w/ Mag. Base
- 51 ON/OFF Magnetic Part Picker



- 54 Nomad™ Table, Accessories & Kit
- 55 Standard Duty, Foldable Sawhorse Legs
- 55 NOMAD Table Legs
- 56 Scout Tripod, Work Stand
- 57 Notcher

## GAS HANDLING

- 52 EZ-View Gas Cylinder Valve Indicators
- 52 Gas Flow Meter
- 53 Gas Grabbers
- 53 Gas Hooks
- 53 Cylinder Cart

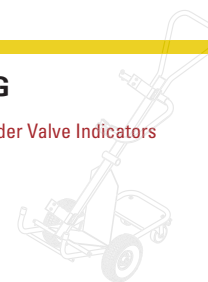

\* Throughout this catalog, all magnetic force is based on 10 mm thick flat steel surface except where indicated. Magnetic products must be used for tack welding only and removed before completing weld. Avoid prolonged exposure of magnetic products to heat sources of 175°F / 80°C and above.

\* All product, product specifications and data are subject to change without notice to improve reliability, function, design or otherwise. Please check online for updated information and details.

\* WARNING: Cancer and Reproductive Harm - [www.P65Warnings.ca.gov](http://www.P65Warnings.ca.gov)

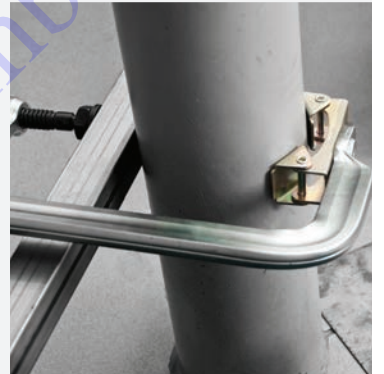

**4 functions in 1 Clamp**



**1 Standard**  
Sliding Arm Clamps are 10x faster than a C-Clamp!



**2 Pipe**  
Add the exclusive V-Pad to create a Pipe Clamp!

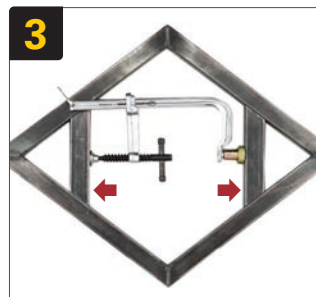

**3 Spreader**  
Reverse the clamp arm and create a Spreader Clamp.



**4 Step-Over**  
Add the Extender Block to create a Step-Over Clamp.



# F-Clamps

The most versatile Sliding Arm Clamps in the market.

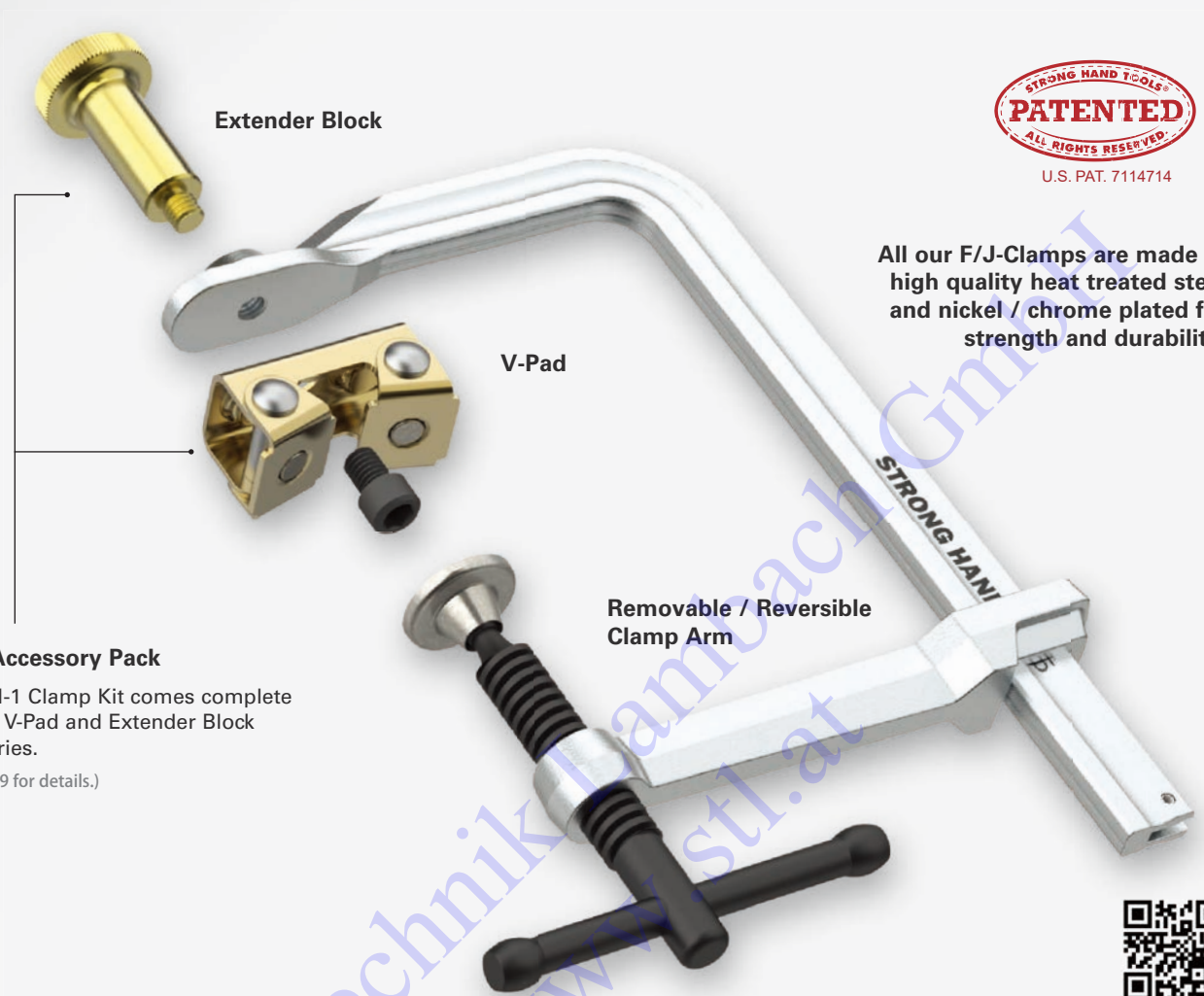

U.S. PAT. 7114714

All our F/J-Clamps are made of high quality heat treated steel and nickel / chrome plated for strength and durability.

### 4-in-1 Accessory Pack

The 4-IN-1 Clamp Kit comes complete with the V-Pad and Extender Block accessories.

(See page 9 for details.)

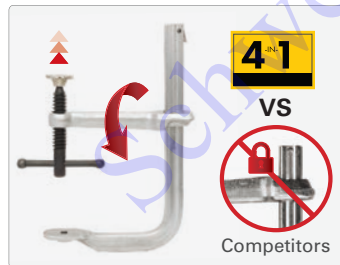

### Clamp Arm

**- Removable**  
**- Reversible**

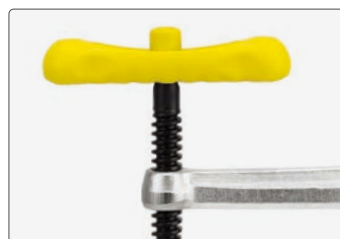

### Ergonomic Comfort Handle included with G/M Rail

UG Models: Plastic Handle + Cap  
UM Models: Plastic handle ONLY



### UD Models:

Remove the Key Ring.



### UE, UF, UG, UM Models:

**Quickest Removal:** Press the Spring Stop to slide the clamp arm ON & OFF



### UP Models:

Removable Fasteners

# F-Clamps

The most versatile Sliding Arm Clamps in the market.

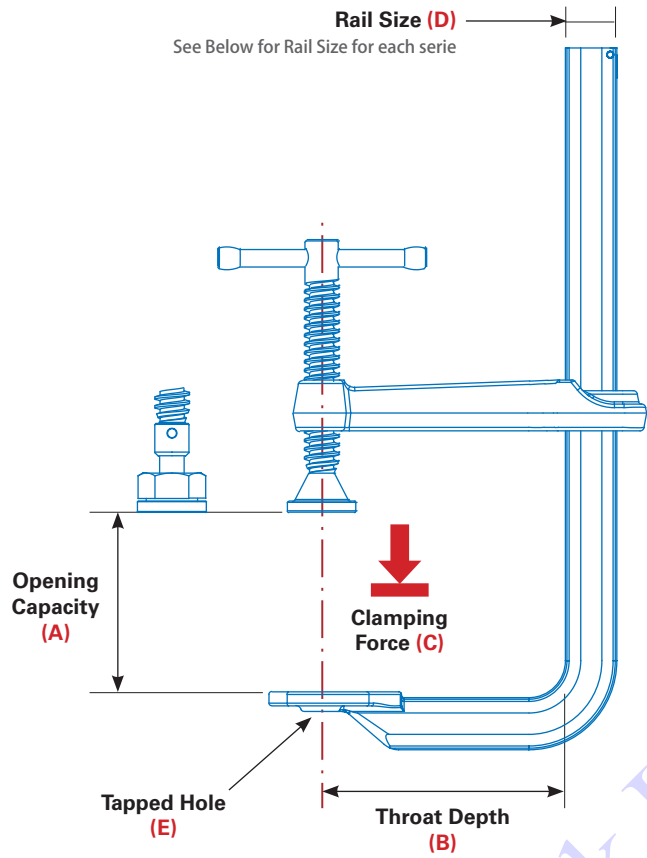

**Standard Pad**



**Replaceable Heavy Duty Pad**

CREATE YOUR OWN 4-IN-1 KIT WITH THE 4-IN-1 ACCESSORY PACK (page 9)



**Tapped Hole (E)**  
For attaching accessories such as the V-Pad or Extender Block.

\* Throughout this catalog, You can identify the features of our clamping tools with the help of designated letters:

- A:** Opening Capacity (mm)
- B:** Throat Depth (mm)
- C:** Clamping Force (kg)

- D:** Rail Size (mm)
- E:** Tapped Hole
- L:** Overall Length (mm)

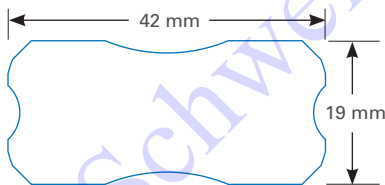

**UP series**  
Rail size (D): 42 x 19 mm

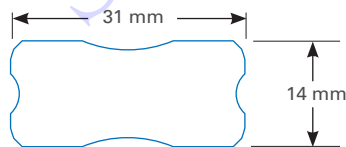

**UM series**  
Rail size (D): 31 x 14 mm

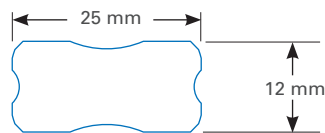

**UG series**  
Rail size (D): 25 x 12 mm

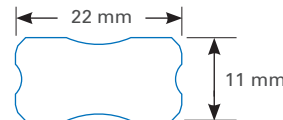

**UF series**  
Rail size (D): 22 x 11 mm

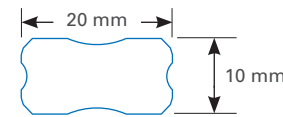

**UE series**  
Rail size (D): 20 x 10 mm

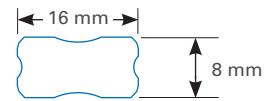

**UD series**  
Rail size (D): 16 x 8 mm



**UB series**  
Rail size (D): 13 x 6 mm

(1:1)



## F-Clamps

The most versatile Sliding Arm Clamps in the market.



### HEAVY DUTY

Clamping Force (C): 2,200 kg  
 Throat Depth (B): 180 mm  
 Rail Size (D): 42 x 19 mm  
 Tapped Hole (E): M10  
 Come with Heavy Duty Pads

Part No.	A (mm)	Weight (kg)	4-IN-1 Part No.	Weight (kg)
UP125M	318	5.5	-	-
UP165M	419	6.2	-	-
UP205M	521	6.8	UP205M-C3	7.3
UP245M	622	7.5	-	-
UP405M	1,020	10.0	-	-
UP605M	1,537	12.7	-	-

### MEDIUM DUTY

Clamping Force (C): 350-1,100 kg  
 Tapped Hole (E): M10  
 Comfort Handle for G/M rail  
 Spring Stop

Part No.	A (mm)	B (mm)	C (kg)	Standard Pad	Weight (kg)	4-IN-1 Part No.	Weight (kg)
UM205M	521	140	1,100	Heavy Duty	4.0	UM205M-C3	4.5
UM165M	419	140	1,100	Heavy Duty	3.5	UM165M-C3	4.0
UM125M	318	140	1,100	Heavy Duty	3.2	UM125M-C3	3.5
UM125PM	318	140	1,100	√	3.1	-	-
UM105M	267	140	1,100	Heavy Duty	2.9	-	-
UM105PM	267	140	1,100	√	3.0	UM105PM-C3	3.4
UM85M	216	140	1,100	Heavy Duty	2.7	-	-
UM85PM	216	140	1,100	√	2.9	UM85PM-C3	3.0
UM65M	165	140	1,100	Heavy Duty	2.5	-	-
UG205M	521	120	550	√	2.2	-	-
UG125M	318	120	550	√	1.8	UG125M-C3	2.1
UG85M	216	120	550	√	1.6	UG85M-C3	1.9
UF100M	254	120	460	√	1.3	-	-
UF65M	165	120	460	√	1.1	UF65M-C3	1.3
UE125M	318	100	380	√	1.2	-	-
UE85M	216	100	380	√	1.1	-	-
UG1657M	419	180*	350	√	3.0	-	-
UG1257M	318	180*	350	√	2.7	UG1257M-C3	2.9

\* Deep Throat

### LIGHT DUTY

Clamping Force (C): 230 kg  
 Throat Depth (B): 83 mm  
 Rail Size (D): 16 x 8 mm  
 Tapped Hole (E): M8  
 Come with Standard Pad  
 Key Ring Stop

Part No.	A (mm)	Weight (kg)	4-IN-1 Part No.	Weight (kg)
UD85M	216	0.6	-	-
UD65M	165	0.5	UD65M-C3	0.7
UD45M	114	0.4	UD45M-C3	0.6

# J-Clamps, Ratchet Action & MagSpring™ Clamps

Quick-Set Clamps for fast, convenient clamping.

## STEP-OVER J-CLAMP

Tapped Hole (E): M10 & M8

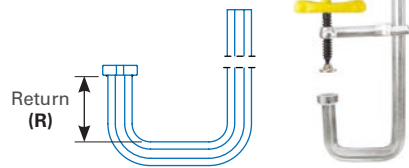

Part No.	A (mm)	B (mm)	R (mm)	C (kg)	D (mm)	Pad	Weight (kg)
UM205JM	521	140	100	1,100	31 x 14	Heavy Duty	4.2
UM125JM	318	140	100	1,100	31 x 14	Heavy Duty	3.7
UG105JM	267	120	76	550	25 x 12	Standard	2.3
UF100JM	254	120	76	460	22 x 11	Standard	1.5
UD45JM	114	83	50	230	16 x 8	Standard	0.6

## RATCHET ACTION CLAMPS

Ratchet mechanism ensures rapid, vibration and torsion resistant clamping.

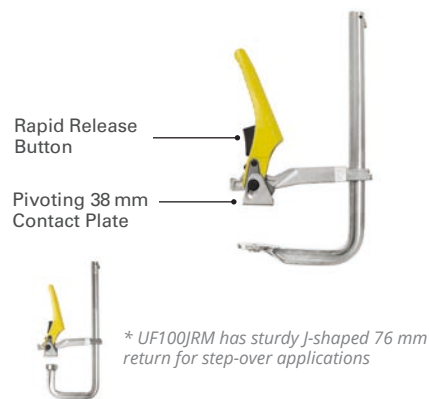

- Quick to setup, unlock, and remove in high volume clamping applications.
- Even clamping force. Ideal for repetitive clamping setups.
- M10 threaded hole for adding accessories.

Part No.	A (mm)	C (kg)	D (mm)	Weight (kg)
UG205RM	521	550	25 x 12	2.6
UG125RM	318	550	25 x 12	2.2
UG85RM	216	550	25 x 12	1.6
UF100RM	254	460	22 x 11	1.3
UF100JRM*	254	460	22 x 11	1.4
UF65RM	180	460	22 x 11	1.2

## MAGSPRING™ CLAMPS

The spring-loaded, one-handed clamp with quick-set V-Pad.



The Spring Arm in conjunction with the V-Pad allows users to free up one hand to position the workpiece. Magnetic V-Pad instantly adjusts for different shapes: round, flat, and angle steel surfaces.

Part No.	A (mm)	B (mm)	C (kg)	E (mm)	Weight (kg)
UBV65M	115	64	140	M6	0.4
UDV45M	75	83	230	M8	0.5
UDV65M	115	83	230	M8	0.6

## SLIDE-ON SIDEKICKS

Mount onto sliding arm clamps to gain side clamping abilities. Stroke and reach of clamp can be modified by changing the pad with a longer or shorter fastener.

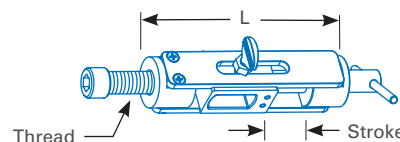

Part No.	L (mm)	Stroke (mm)	Thread	For Clamps	Weight (kg)
XDS	80	25	3/8-16	UD Series	0.3
XFSM	110	35	M12	UF Series	0.6
XGSM	110	35	M12	UG Series	0.6
XMSM	110	35	M12	UM Series	0.6

# Clamps Accessories

## Replacement Parts and Accessories.



All Accessories



### 4-IN-1 PACKAGES (FOR F-CLAMPS)

Convert all F-Clamps into 4-IN-1 Clamps. Includes a V-pad, an Extender Block, and a screw.

\* Please check our website for individual Extender Blocks and V-Pads information.



U.S. PAT. 7114714

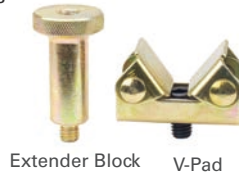

Extender Block V-Pad

Part No.	V-Pad	Extender Block	For Clamps	Weight (kg)
XDVBM	XDV	XDB1M	UD Series	0.1
XFVBM	XFV	XFBM	UE, UF, UG Series	0.2
XMVBM	XMV	XMB2M	UM, UP Series	0.5
XPVBM	XPV	XPB3M	UP Series	0.8

### F-CLAMPS REPLACEABLE PARTS

Replaceable Arm & Spindle Kits

\* Please check our website for individual clamp arms and spindles information



XMR2

Part No.	Replaceable Arm & Spindle Kits	Weight (kg)
XDR	for UD Series	0.2
XER	for UE Series	0.4
XFR	for UF Series	0.5
XGR	for UG Series	0.6
XMR2	for UM (Equipped w/ Heavy Duty Pad)	1.1
XMRP2	for UM (Equipped w/ Standard Pad)	1.0
XPR	for UP Series	2.0

### REPLACEABLE PADS

Heavy Duty Replacement joints and pads for UM & UP clamps.



XMJ (Roll pin included)

XMA1

Spring-loaded standard pads for light & medium duty clamps.



Part No.	Description	Weight (kg)
XMJ	Joint & Pad Kit for UM & UP Clamps	0.18
XMA1	Replacement Pad only for XMJ	0.09
XDP	Standard Pads for UB, UD Series	0.02
XFP	Standard Pads for UE, UF, UG Series	0.04
XGP	Standard Pads for UG Series	0.05
XMP	Standard Pads for UM Series	0.10

### MAGNETIC TOP V-PADS

Add the aluminum magnetic top V-Pad onto the swivel pad to hold round, square, flat, and angled stock.



U.S. PAT. 1030789



(Top View)

Part No.	For Clamps	For Pliers	Weight (kg)
T64217	UB, UD Series	PT07K	0.02
T64219	UE, UF, UG Series	PT09K, PT11K, PT14K	0.02

### CLIP-ON TOP V-PADS

Attach to the top of F-Clamps equipped with Standard Pads.



Part No.	Material	For F-Clamps	Weight (kg)
XDA2	Steel	UD Series	0.09
XFA2	Steel	UE, UF, UG Series	0.13
XMA2	Steel	UM, UP Series	0.27
XDA2S	Stainless Steel	UD Series	0.09
XFA2S	Stainless Steel	UE, UF, UG Series	0.13
XMA2S	Stainless Steel	UM, UP Series	0.27

### SCREW-ON TOP V-PADS

Attach to the top of F-Clamps equipped with Heavy Duty Pads.



Part No.	Material	For F-Clamps	Weight (kg)
XMA	Steel	UM, UP Series	0.28
XMAS	Stainless Steel	UM, UP Series	0.28

# Adjust-O™ Magnet Squares

Angle magnet squares with the convenience of On/Off switches.



## ADJUST-O™ MAGNET SQUARES



**DOUBLE Plate**  
Optimize magnetic force(-HD models)

**On/Off Switch**  
Mid point switch position: for alignment / easy part placement.

The fast & easy way to hold metal workpieces at 30°/ 60°, 45°, and 90°.

Made with strong rare earth magnets. Ideal for round and square tubing, angle, and flat stock. Easy to clean. Fully enclosed for easier cleaning. Simply turn Off and wipe.

Turn the magnet Off or at the mid-point position when setting up, turn On when you're ready to work. Fast and safe set-up!

Part No.	Max. Pull Force (kg)	Dimension (mm)	Weight (kg)
MSA45	30	110 x 95 x 25	0.5
MSA46-HD	40	110 x 95 x 29	0.7
MSA47	35	150 x 130 x 32	1.0
MSA48-HD	75	150 x 130 x 35	1.4
MSA53-HD	65	150 x 130 x 35	1.4

NEW ITEM

## TAB FOR MSA MAGNETS

XMT30 are 3 tabs for MSA Magnets to position and align your stock materials properly.



XMT30



Part No.	Weight (kg)
XMT30	0.14

## THIRD-AXIS MAGNETIC POSTS

Include three posts per set.

Quickly and easily set-up 3-sided work such as tank and gusset. Use on either side of the magnet squares.



MXE13



Part No.	Max. Pull Force (kg)	Weight (kg)
MXE13	7.3	0.09

## A-FRAME HD MAGNET



For large and heavy stock holding.

Larger / wider magnets with large contact surface and stability. ON/OFF switches function with weaker force when lever at **mid-position**, for adjustment / placement of parts.

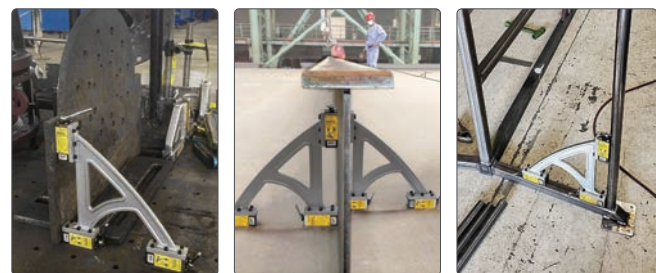

Part No.	Max. Pull Force (kg)	Dimension (mm)	Weight (kg)
MS2-300	120	330 x 330 x 32	3
MS2-450	300	550 x 550 x 45	11

# Adjust-O™ Magnet Squares

Angle magnet squares with the convenience of On/Off switches.



## ADJUST-O™ 90° DUAL SWITCH



For professional jobs that demand strong hold down forces. Holds flat and round metal work pieces.

- Two On/Off switches for independent operation. Turn the magnets Off when setting up, turn On when you're ready to work. Easy and safe set-up!
- Machined flat and V-surfaces are ideal for round and square tubing, angle, and flat stock.



**2 x On/Off Switch**  
For independent operation



**V-Groove**  
For holding round & flat stock.

Part No.	Max. Pull Force (kg)	Dimension (mm)	Weight (kg)
MS2-80	55	152 x 152 x 38	1.2
MS2-90	120	197 x 197 x 48	2.7

## ADJUST-O™ ANGLE MAGNET

- Adjustable from 30° - 275° with two On/Off switches.
- Machined flat surfaces and nickel/chrome body.
- V-Groove surfaces securely hold round and square tubing, angle, and flat stock.

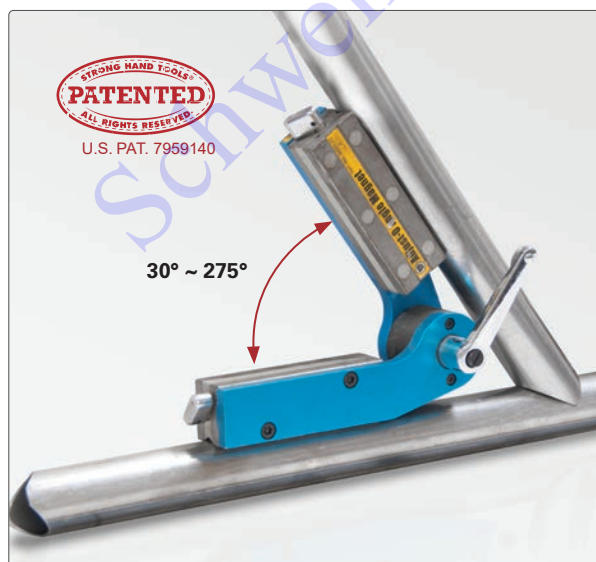

**Machined V-Groove**  
For holding round & flat stock.



**Calibration w/ Vernier**



**Adjustable Handle**  
For setting & locking the desired angle.



**2 x On/Off Switch**

Part No.	Max. Pull Force (kg)	Dimension (mm)	Weight (kg)
MAV120	50	197 x 197 x 95	2.4

# Inside/Outside Angle Magnets & Corner Magnets

Hold stock using the Inside or Outside edges!

## INSIDE/OUTSIDE ANGLE MAGNETS

The Inside / Outside Angle Magnets are constructed from two independent rectangular magnets for consistent, undiminished magnetic force when both sides are attached to workpieces. They hold and position sheet metal, round pipes, square, angled or flat stock. Ideal to hold stock from the outside when inside access is difficult.

- Two magnets inside + double plates for maximum pull
- Narrow profile for use in tight spots.
- MLD serie features fixed angles: 90°, 30°/60°.
- MLA serie can be adjusted from 30° to 270°
- Angles Setting Pin, included in MLA serie, sets the angle from 30°, 45° and 90°



Demo Video



Adjustable angle



Pin to set 45°



Breakaway force



Lock angle

Part No.	Description	Height (mm)	Width (mm)	Thickness (mm)	Max. Pull Force (kg)	Weight (kg)
MLDT350	Combo Pack, 1x MLD300 + 1x MLD500 (MLD300 and MLD500 not to be sold separately)					0.5
(MLD300) (MLD500)	Fixed Angle, 90°, 30°/60°	76 125	52 85	14 18	9 15	
MLD600	Fixed Angle, 90°, 30°/60°	165	110	20	18	0.8
MLA450	Adjustable Angle, 30 ~ 270°	120	120	18	12	0.5
MLA600	Adjustable Angle, 30 ~ 270°	156	156	20	15	0.9

## CORNER MAGNETS

- Create 90° corners by holding from the outside, providing you with an unobstructed area for inside tack welds.
- One side corner "relief" provides clearance for tall lips.
- Use the outer edges of the Corner Magnet for setting up materials at 60°.



The compact and low profile Corner Magnet is ideal for light duty holding of stock at 90°.



Use the outer edges of the Corner Magnet to hold stock at 120°.

Part No.	Description	Dimension (mm)	Max. Pull Force (kg)	Weight (kg)
MST327	Twin Pack 90° & 60°	83 x 95 x 16	14	0.4

# Multi-Angle Magnets

Unique 30°/60°, 45° and 90° angle combination.



## STANDARD MAGNET SQUARES

Holding at multiple angles while soldering, brazing, and welding.

- Center hole for easy handling.
- Aluminium enclosed for easier cleaning.



**MS346B** 30°/60°, 45°, 90°    **MS346C** 30°/60°, 45°, 90°    **MS45** 45°, 90°    **MS60** 60°, 90°



Part No.	Max. Pull Force (kg)	Dimension (mm)	Weight (kg)
MS346B	30	86 x 75 x 20	0.4
MS346C	40	113 x 98 x 23	0.8
MS45	30	113 x 98 x 19	0.5
MS60	25	113 x 98 x 19	0.5

## MINI MAGNET SQUARES

Just 58 mm height low profile magnet squares hold stock at 30°/60°, 45°, 90°. Use as many as needed for light duty holding of stock in tight, hard to reach areas. Full aluminum rim enclosure for easy cleaning.

- Angles: 30°/60°, 45°, 90°
- Dimension (each): 59 x 50 x 16 mm
- Maximum Pull Force (each): 10 kg



Part No.	Package	Weight (kg)
MS346AT	Twin Pack	0.3
MS346AK	6-Pack	0.8

## XYZ MINI MAGNET SQUARES

Quickly & easily set-up 2 or 3-Axis workpieces, such as gussets and steel panels.

Unique Magnetic Face Plate features two rare earth disc magnets for 3rd axis holding.

**Rotate** and **slide** Magnetic Face Plate into position as needed for each unique applications.

Use the face plate as an edge guide when joining square tubes and sheet metal.

- Angles: 30°/60°, 45°, 90°
- Dimension (each): 59 x 50 x 22 mm
- Max. Pull Force (each): 10 kg

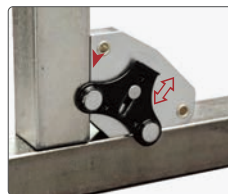

The face plate can be slid out of the boundary edges as edge guide.



Part No.	Package	Weight (kg)
MST348	Twin Pack	0.3

### A better, faster way to magnetically hold tabs in place.

- **New 2.0 (MET11 and MNT15):** Available with more magnets that are now fully replaceable and provide 3X more magnetic holding force than the original design. Allow you to quickly and easily change out weak or damaged magnets.
- **Magnetic Holding:** Hold tabs and small metal pieces, parallel or perpendicular to your substructure.
- **V-Pads:** MagTabs feature an integrated V-Pad that allows you to magnetically attach to various types of surface shapes; flat, curved, or with varying angles.

\* Remove the MagTab bracket to use the Adjustable Magnetic V-Pad for light duty holding of steel plates. See page 15 for details.

### 3X STRONGER, Better Accuracy

4+2 Replaceable Magnets



MET11

knurled knob that offers better grip and comfort when tightening to lock in the tab location.



Slot on the MagTab bracket for workpiece alignment.

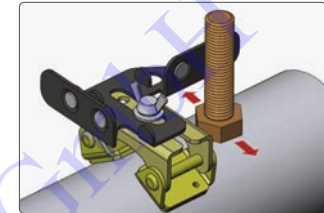
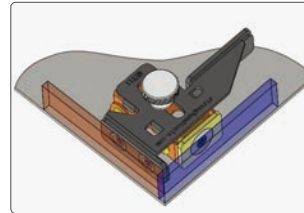

Part No.	Dimension (mm)	Max. Pull Force (kg)	Weight (kg)
MNT15	130 x 110 x 70	35	0.4
MET11	114 x 66 x 50	20	0.2
MFT10	101 x 76 x 33	8	0.2
MDT50	71 x 55 x 44	6	0.1

\* Magnetic force is based on 2 mm flat steel surface.

Designed and built from a single piece of cast aluminum, the MagTab PRO provides solid and sturdy magnetic holding of tabs in larger applications.

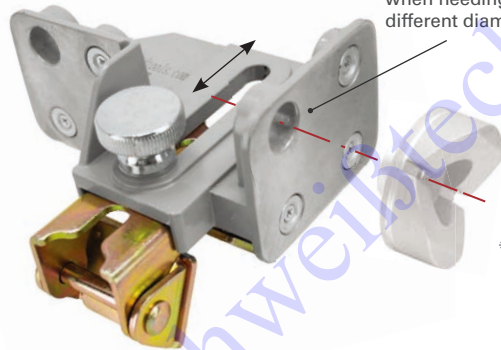

Two 16 mm Mounting Holes for V-Blocks (T64216, optional) when needing to hold on to different diameter size tubes.

\* V-Block T64216 (NOT included)

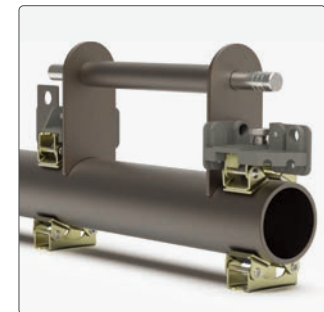
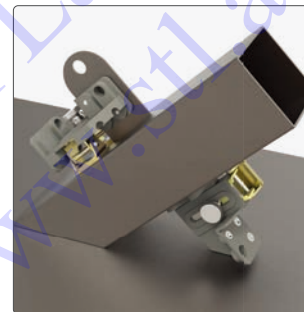

Part No.	Dimension (mm)	Max. Pull Force (kg)	Weight (kg)
MNT17	130 x 99 x 86	15	0.8
MPT18	162 x 135 x 89	30	0.9

\* Magnetic force is based on 10 mm flat steel surface.

## REPLACEMENT MAGNETS

Replaceable Magnets with Flush Mount Screws. Compatible with MagTab 2.0 featuring replaceable magnets.



Part No.	Descriptions	Weight (kg)
MRP6	Replaceable Magnets for AGK320 and AGK450, 6 pc.	0.04
MRP8	Replacement Magnets for MET11, 4 + 2 pc.	0.04
MRP9	Replacement Magnets for MNT17, 4 + 6 pc.	0.04
MRP13	Replacement Magnets for MPT18, 8 + 6 pc.	0.09
MET16	1x MET11 + 1x MRP8	0.32

# V-Pad Kits

Ideal for positioning and holding steel or pipes.



## V-PAD KITS

Light duty & tight spot holding! Build, Hold, and Position steel.

Strong rare earth magnets to hold and position round, flat, and square parts in light duty sub-assembly applications!

### THREE OPTIONS AVAILABLE:

#### Magnets on both pad face and the bottom

**BEST SELLER**

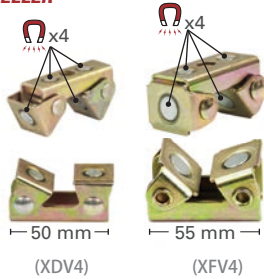

(XDV4)  
Width: 50 mm  
Max. Pull Force: 6 kg

(XFV4)  
Width: 55 mm  
Max. Pull Force: 8 kg

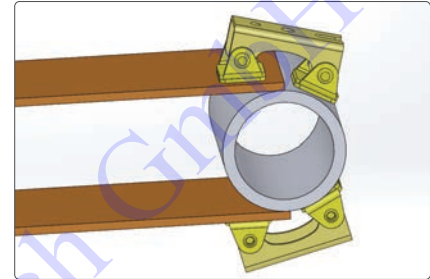

Part No.	Kit Contents	Weight (kg)
MVDF44	2 pcs. V-Pads (XDV4) + 2 pcs. V-Pads (XFV4)	0.4

#### Magnets on pad face only

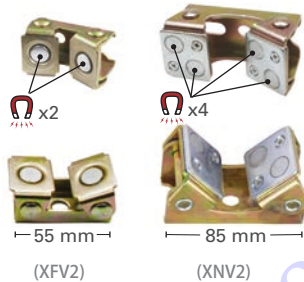

(XFV2)  
Width: 55 mm  
Max. Pull Force: 8 kg

(XNV2)  
Width: 85 mm  
Max. Pull Force: 16 kg

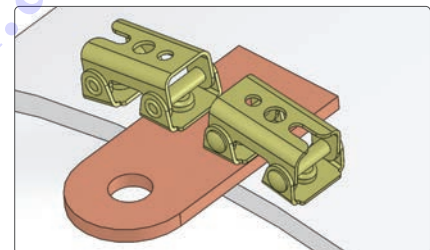

Part No.	Kit Contents	Weight (kg)
MVFN46	2 pcs. V-Pads (XFV2) + 2 pcs. V-Pads (XNV2)	1.1

#### Magnets on the flat side (bottom) only

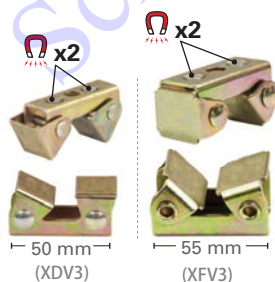

(XDV3)  
Max. Pull Force: 3 kg  
Comfortably holds  $\varnothing 13 \sim 150$  mm round tubings.

(XFV3)  
Max. Pull Force: 4 kg  
Comfortably holds  $\varnothing 25 \sim 200$  mm round tubings.

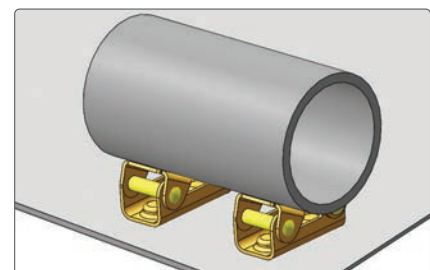

Part No.	Kit Contents	Weight (kg)
MVDF42	2 pcs. V-Pads (XDV3) + 2 pcs. V-Pads (XFV3)	0.3

# Pipe Alignment and Fit-Up Clamps

The efficient way to accurately fit-up round pipes for butt welding.

## PIPE ALIGNMENT CLAMPS WITH QUICK-ACTING LEVER

The New Pipe Alignment Clamp with Quick-Acting Lever is a fast, accurate fit-up clamp with a rugged frame.

Get a well-balanced hold on the clamp with the two wide Grip Plates while pressing the Quick-Acting Lever. The screw smoothly glides up and down for fast insertion and removal after welding.

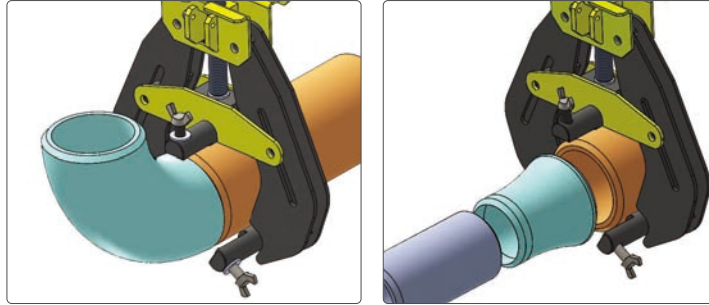

Pipe to Elbow

Pipe to Reducer

Part No.	Pipe Diameter Capacity (mm)	Weight (kg)
CPA60	50 ~ 150	5.0
CPA120	115 ~ 305	7.8

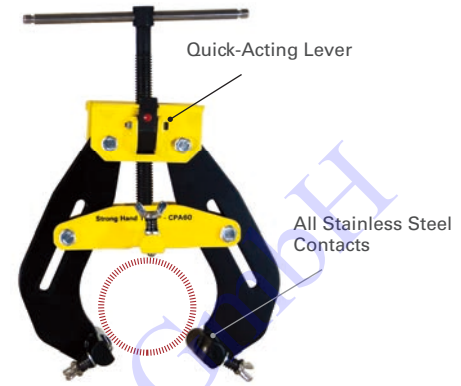

### PRESS - SLIDE - SET

Wide Grip Plates make this Pipe Alignment Clamp easier to handle, with less user fatigue.

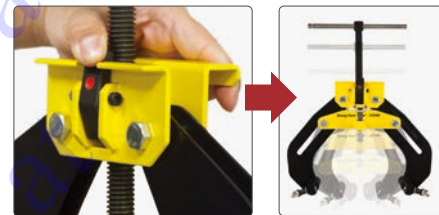

## PIPE FIT-UP CLAMPS

A compact, light weight, portable clamp for the quick fit-up of round pipes and flanges for butt welding. 50 - 75% lighter than traditional alignment clamp. Easy-to-Use design for the rapid, repeated loading and unloading of workpieces.

### Pre-set clamp opening for fast setup:

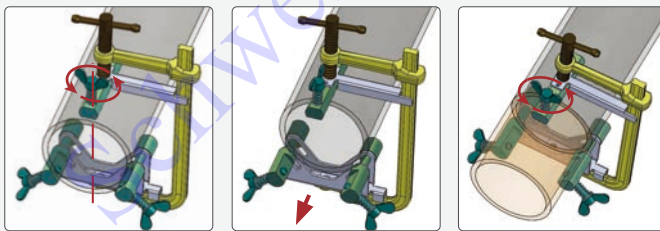

Turn three adjustment screws to preset.

Loosen the main clamp arm.

Tighten the main clamp arm.

Part No.	Pipe Diameter Capacity (mm)	L (mm)	Weight (kg)
CPL45	50 ~ 100	240	1.3
CPL75	100 ~ 140	305	2.1



Demo Video

All Stainless Steel Contacts  
89 mm L Clamp Rods



Fine Adjustment Screws

# "The Spider" Internal Pipe Fit-Up Clamp

The efficient way to accurately fit-up round pipes for butt welding.



## "The Spider" Internal Pipe Fit-Up Clamps



### Precision Alignment for Pipe Welding.

"The Spider" Internal Fit-Up Clamp ensures precise alignment for welding pipe to flange, or pipe to pipe.

- CNC Machined for Precise Alignment:**  
 CNC machining ensures smooth adjustments & accurate alignment, making it easy to achieve optimal positioning for every weld.
- Stainless Steel Contact Points:**  
 All contact points are made from durable stainless steel, offering superior resistance to corrosion and wear.
- Dual Locating Legs Adjustment:**  
 Two knobs for independent adjustment of the front and rear sections. Expand one set of Locating Legs to anchor securely within the pipe, while the second set of legs adjusts to perfectly align the pipe or flange.
- Versatile Fit:**  
 Accommodates a variety of flanges from 4" to 12" and pipe internal diameters from 83 mm to 320 mm, providing flexibility for various welding projects.



Used for Flange Pipe



Used for Pipe Butt-welding

Part No.	Dimension (mm)	Fit Flanges (in)	Fit Pipes A (mm)	Pipe Weight Capacity	Weight (kg)
CSA480	390 x 70 x 70	4 - 8	83 - 203 (ID)	Less than 10 kg	2.5
CSA812	525 x 150 x 130	8 - 12	203 - 320 (ID)	Less than 25 kg	7.8

## Magnetic Alignment Pin

Quickly pop the self-aligning pin heads onto some flange holes and level with the built-in bubble vial. No need to take off your gloves and fiddle with screws. Combo Kit includes: 1x MAP200 and 1x MPCH250 (See page 50 for details).

- Wide adaptability, suitable for ferrous materials flanges with hole spacing of 85 - 170 mm and hole diameter of 14 - 48 mm.
- Super strong magnets, say goodbye to traditional threaded assembly, securely adheres to the flange hole.
- Leveling bubble vial included for efficient horizontal calibration.
- CNC machined and aluminum anodized body to ensure high precision.



Part No.	Description	Dimension (mm)	Weight (kg)
MAP200	Magnetic Alignment Pin	250 x 62 x 48	0.7
MAPCH300	Magnetic Alignment Pin * 1 + Magnetic Pipe Centering Head * 1	275 x 230 x 82	1.4

NEW ITEM

NEW ITEM

# New Special Pliers

Designed for both professionals & DIYers.

NEW ITEM

## Adjustable Pliers with Spring

Built with forged construction, these Water Pump Pliers have a slim profile for easy access in confined spaces. The hardened teeth offer a strong grip, while the return spring and dipped handles provide quick jaw opening and a non-slip grip for enhanced precision. The phosphated finish adds corrosion protection for long-lasting use.



Part No.	Max. Clamping Capacity (mm)	Dimension (mm)	Weight (kg)
PBX500	38	178 x 45 x 12.5	0.2

NEW ITEM

## Extractor - Screw Pliers

The Extractor is a compact, feature-packed tool built for precision and durability. At 178 mm long with a 10 mm wide nose, it's ideal for detailed tasks and tough jobs alike.

Spring-loaded, ergonomic handles for comfort and ease of use. A locking clip keeps the tool securely closed when not in use.

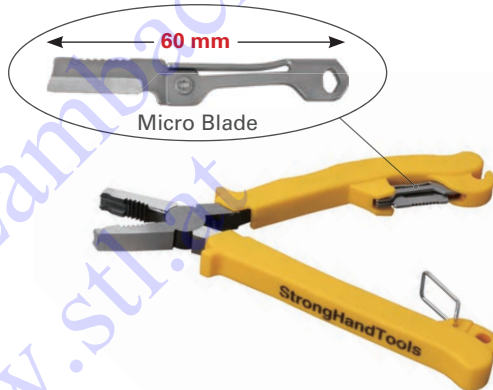
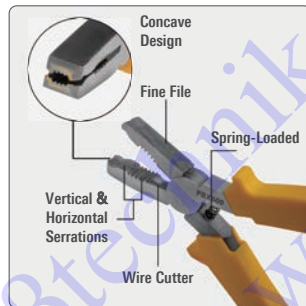

Part No.	Pliers Nose Width (mm)	Dimension (mm)	Weight (kg)
PBX600	10	178 x 68 x 13.5	0.2

NEW ITEM

## Extractor Locking Pliers

Designed for both professionals & DIYers, this tool is built to handle a wide range of tasks with ease. The versatile jaw design & multiple features make it an essential multi-tool for various tasks.

The pliers are more than just pliers – they're a game-changing multi-tool. It is a reliable, versatile tool that's perfect for any job.

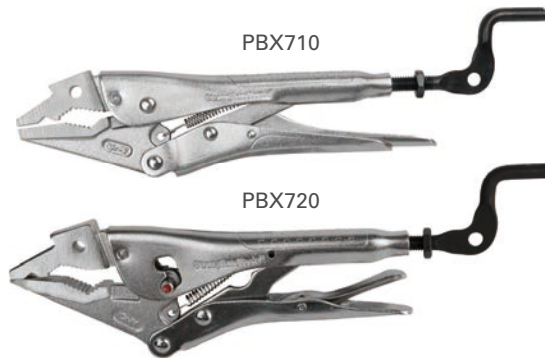
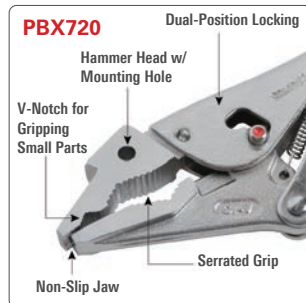

Part No.	Max. Clamping Capacity (mm)	Dimension (mm)	Weight (kg)
PBX710	25	245 x 55 x 15.5	0.4
PBX720	55	250 x 60 x 17.5	0.4

# Pipe Pliers

The convenient way to hold round or square tubes for butt-welding.



## LARGE DIAMETER PIPE PLIERS

The V-Pad holds round, square, or angled stock in different sizes.

V-Pad on top jaw and spindle on the bottom jaw securely clamp the round pipe against a flat surface.

Quick-release trigger and unique crank handle for fast, easy jaw opening and pressure adjustment.

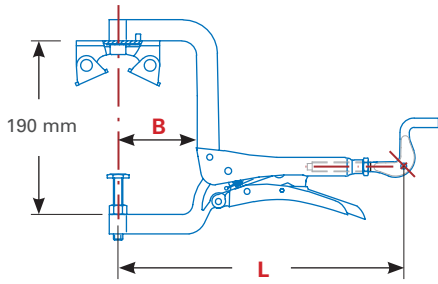

\* The black clip lets you to lock the v-pad alignment parallel with the plier jaws. Remove the clip for free rotation of the v-pad.

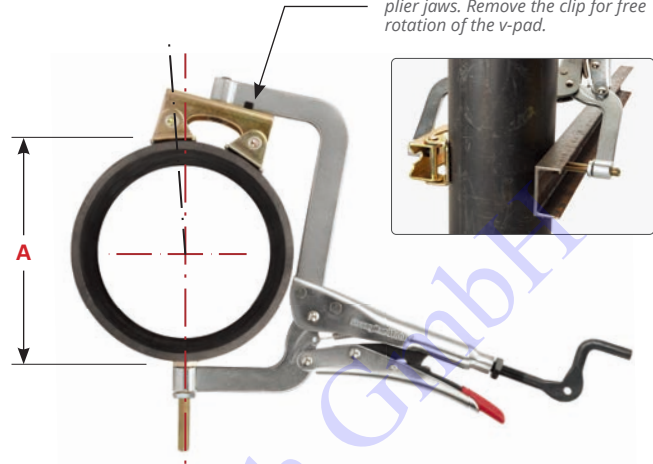

Part No.	A (mm)	B (mm)	L (mm)	Thread	Weight (kg)
PG1107V	150	80	290	M10	1.3

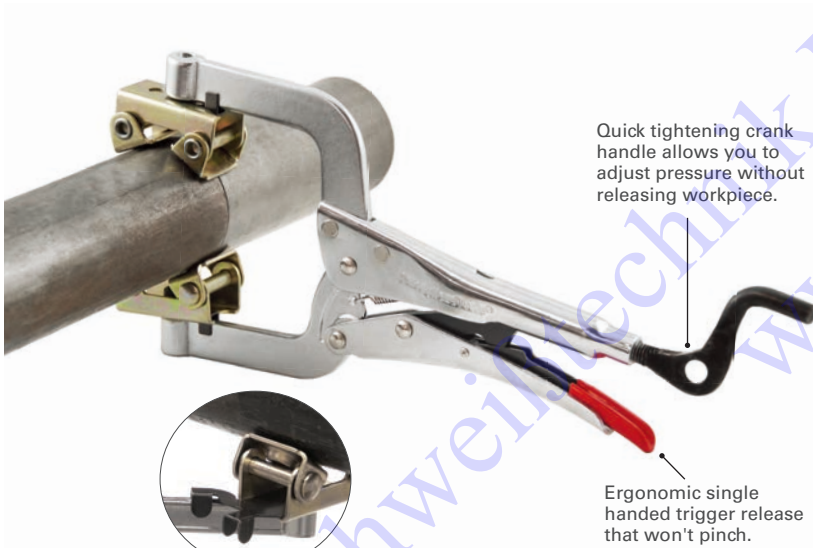

## PIPE PLIERS

The convenient way to hold round or square tubes for butt-welding. The V-Pads on the Pipe Pliers adapt to many different shapes and sizes.

- Wide opening allows the Pipe Pliers to hold up to 64 mm diameter pipes.
- Two V-Pads provide a better clamping surface.
- Adjustable top spindle for holding pipes of varying sizes.

\* Magnetic V-Pads and Stainless Steel V-Pads (Part No. XFVS) also available separately. See [stronghandtools.com](http://stronghandtools.com) for details.

Quick tightening crank handle allows you to adjust pressure without releasing workpiece.

Ergonomic single handed trigger release that won't pinch.

0° & 45° angle clip in PG635V allows angled clamping.

**PG114V**  
**BEST SELLER**

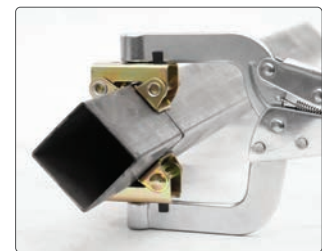

Part No.	Top V-Pad	Bottom V-Pad	A (mm)	B (mm)	L (mm)	Thread	Weight (kg)
PG622V	Fixed	Fixed	25 - 50	50	150	M8	0.4
PG634V	Fixed	Fixed	50 - 80	76	216	M8	0.5
PG635V	Adjustable	Magnetic 0° & 45° rotatable	38 - 64	76	216	M8	0.5
PG114V	Fixed	Fixed	38 - 64	89	280	M10	1.3
PG115V	Adjustable	Fixed	38 - 64	89	280	M10	1.3

# Pipe Handling Pliers

Handle pipes of all sizes effortlessly.

## SMALL DIAMETER PIPE PLIERS

Small Diameter Pipe Pliers are the convenient way to hold small round pipes for: **Butt-welding** and **Cross joints**.

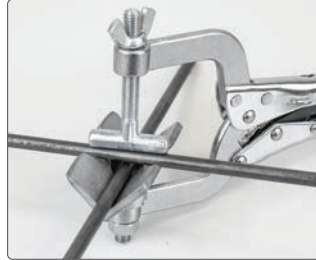

Part No.	A (mm)	B (mm)	L (mm)	Thread	Weight (kg)
PGT621	6 ~ 38	50	150	M8	0.4

## PIPE JOINT PLIERS

- Hold tight, for load-bearing, as much as 22 kg.
- V-Pad on top jaw and spindle on the bottom jaw securely clamp the round pipe against a flat surface.
- Adjustable bracket allows the workpiece to be shifted off-center.
- Two aluminum V-Blocks on the aluminum bracket can be used with additional pliers or clamps for holding on to different diameter size tubes at different angles.



Use w/ MagSpring Clamp to join pipe at angle



Use with F-Clamp w/ Clip-on Top V-Pad to hold pipe at 90 degree

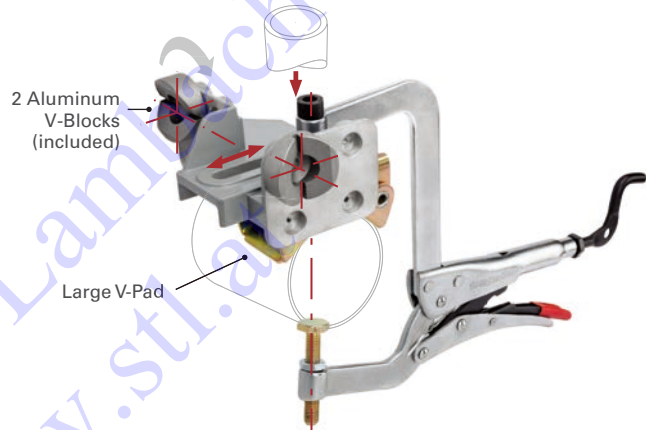

Part No.	Hold Pipe (mm)	B (mm)	L (mm)	Thread	Weight (kg)
PPJ634	Up to Ø63.5	75	240	M8	0.7
PPJ1107	Up to Ø130	80	290	M10	1.7

## CENTER JIG PLIERS

The ultimate solution for precise drilling and secure clamping.

With an integrated jig, these pliers ensure your drill stays centered and doesn't slip when working with round, square pipe, or flat stock materials. With a generous clamping capacity of up to 110 mm, and 5 different hole sizes, these durable pliers provide a secure grip for various tasks.

Jig Hole Sizes: 1/8 , 3/16 , 1/4 , 3/8 , and 5/16

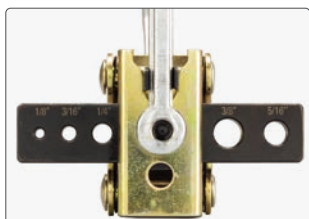

Part No.	A (mm)	B (mm)	L (mm)	Thread	Weight (kg)
PCJ630	150	75	216	M8	0.6

NEW ITEM

# Locking Pliers

Round tip, Swivel and fixed head spindles for flexible clamping.



## C-CLAMP LOCKING PLIERS

Made of forged, heat treated steel with nickel and chrome plating for strength and durability.

- Secure adjustment bar minimizes pop outs.
- Large adjustment screw with hole for adding torque screwdriver
- Ergonomic single handed trigger release that won't pinch

\* Optional Crank Handle See page 26 for details.

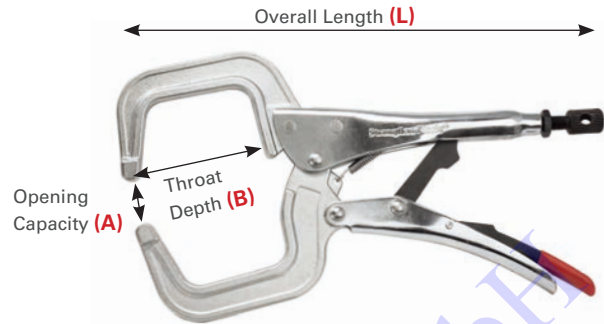

Round Tip

Part No.	A (mm)	B (mm)	L (mm)	Weight (kg)
PR6	50	46	165	0.2
PR115	100	83	280	0.9
PR18	114	254	460	1.4



Swivel Tip

Part No.	A (mm)	B (mm)	L (mm)	Weight (kg)
PR6S	50	45	165	0.3
PR115S	100	83	280	1.0
PR18S	114	254	460	1.4

## MULTI-PURPOSE PLIERS

One swivel pad spindle and a fixed head spindle for flexible clamping. Model PG636 has two threaded jaw holes allow addition of accessories.

Part No.	A (mm)	B (mm)	L (mm)	Thread	Weight (kg)
PG634	100	76	216	M8	0.5
PG636	150	76	216	M8	0.6
PG114	100	89	280	M10	0.9

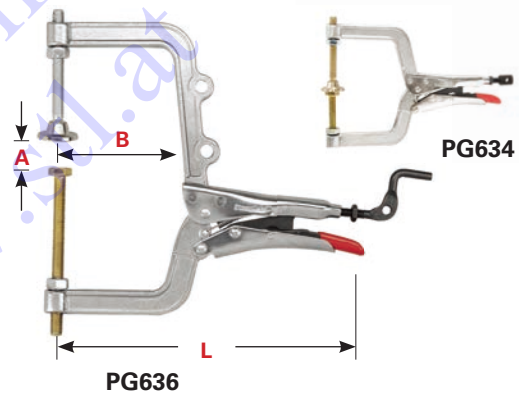

NEW ITEM

## ADJUSTABLE / LONG REACH PLIERS

Adjustable Reach Arms, with no-mar rubber pads.

- Opening Capacity : 100 mm
- Throat Depth: 355, 405, 460, 510 mm
- Overall Length: 585 - 735 mm
- Thread : M10



PGA20

Top adjustable spindle with pivoting head and bottom one has fixed head.



PGA20S

Top and bottom fixed jaws, pivoting heads.



Part No.	Weight (kg)
PGA20M	2.2
PGA20S	2.2

# Strong Grip® Pliers

The Easiest to GRIP, ADJUST, RELEASE.



## BIG MOUTH PLIERS

### Four Adjustment Slots - Large Capacity

- Unique crank handle for FAST opening, closing and in-situ pressure adjustment.
- Serrated jaw surfaces for extra gripping power.
- V-Notch on top jaw for holding small parts.
- Long jaw (63.5 mm) for extra capacity and greater versatility in workholding.

Keep this versatile tool on hand for fast clamping in a variety of jobs!

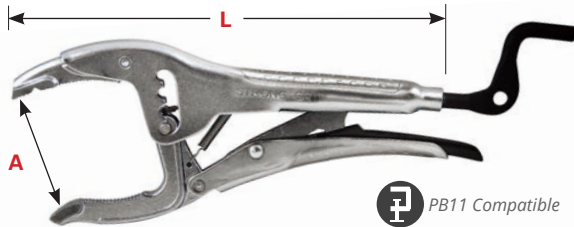

V-Notch for small parts



Four Adjustment Slots



Minimal Hand Spread

Part No.	A (mm)	L (mm)	Weight (kg)
PAJ100	6 ~ 76	250	0.7

\* See page 31 for details of Grounding Big Mount Pliers - PAJ207.

### Unique and Versatile!

## ECONOMY PIPE PLIERS

Large Capacity (76 mm)! Holds round, square, flat or angled. The large (Ø38 mm) swivel pad makes alignment easier!

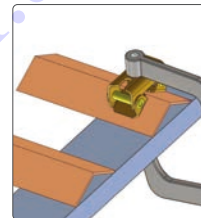
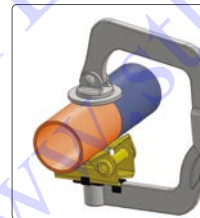

Part No.	A (mm)	L (mm)	Weight (kg)
PVS100	up to 76	360	1.0

### Unique and Convenient!

## C-JAW PLIERS WITH HAMMER HEAD

Unique design provides a convenient hammer when you need it, where you need it! Unique V-groove for twisting wires, pulling pins, loosening nuts and screw heads.

Features Hammer Head  
Flat faces for ramming



Wire Cutter

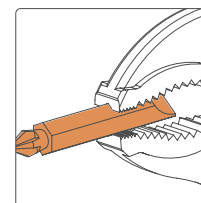
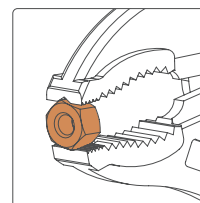

Part No.	A (mm)	L (mm)	Weight (kg)
PCH10	40	300	0.6

### EXPAND-O™ PLIERS

Unique, Reverse-Action Clamping Pliers! Jaws move in opposite directions to push against two surfaces.



Part No.	Min. (mm)	Max. (mm)	Clamping Pressure (kg)	Thread (mm)	L (mm)	Weight (kg)
PE6M	25	44	227	M8	165	0.2
PE10M	35	70	410	M10	254	0.8

### LOCKING CHAIN PLIERS

Clamp odd shaped multiple items. Hold two workpieces, or a group of materials securely in place while you weld. Adjust tension with crank handle.

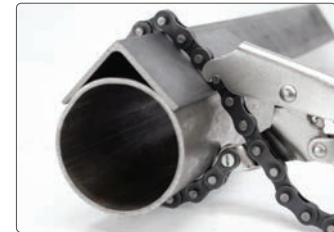

Part No.	Chain Length (mm)	Holds Pipes (mm)	Weight (kg)
PFC1024	600	up to 165	0.9
PFC1036	910	up to 270	1.1
PFC1048	1,200	up to 360	1.4
PFC1072	1,800	up to 550	1.6
PFC10102	2,550	up to 750	1.9

\* Five Replaceable chains available:

Table-mount chain hook and pliers mounts brackets, USED TOGETHER for table mount part hold down. Check our website for detail.



All Accessories

Part No.	Description	Weight (kg)
PXC90	Table Mount Base Kit (2 pc.)	0.5

Part No.	Description	Weight (kg)
PXC24	Replaceable chain 600 mm L	0.3
PXC36	Replaceable chain 910 mm L	0.4
PXC48	Replaceable chain 1,200 mm L	0.6
PXC72	Replaceable chain 1,800 mm L	0.9
PXC102	Replaceable chain 2,550 mm L	1.2

# JointMaster™ Angle Clamping Tools

Fast, precise and affordable clamping tools for corners and T-joints.

## PT634

### The 90° Fixed JointMaster™

- Retractable plate for edge alignment
- V-Grooves for holding round pieces.
- Ideal for holding two pieces of different thicknesses that require individual adjustments.
- Comes with 2 pairs of pliers.

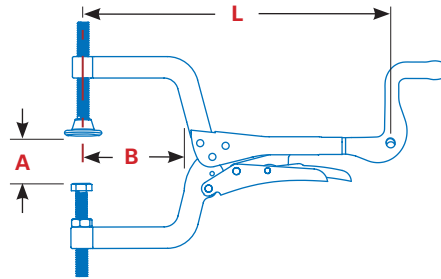

Part No.	A (mm)	B (mm)	L (mm)	Weight (kg)
PT634	76	76	216	1.1

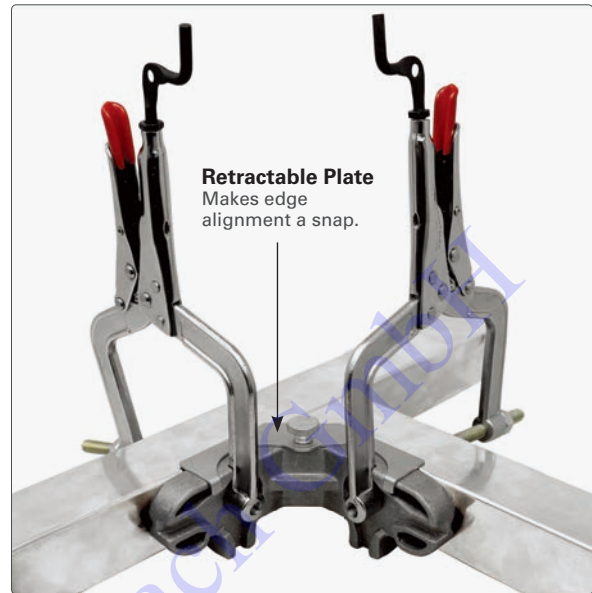

## PA634

### The Adjustable JointMaster™

- Adjustable from 30° - 275°.
- Adjust to the desired angle & "lock" into position with the handle.
- Join round & flat workpieces, or materials with different thicknesses.
- Comes with 2 pairs of pliers.

Part No.	A (mm)	B (mm)	L (mm)	Weight (kg)
PA634	76	76	216	1.1



## PL634

### The single-hand JointMaster™

- Ideal for quick hold and release on metal, wood & synthetic materials.
- A "helping hand" to hold stock firmly at right angles.
- Pivoting Head adjusts for varying thicknesses.
- Comes with 1 pair of pliers.

Part No.	A (mm)	B (mm)	L (mm)	Weight (kg)
PL634	32	76	216	1.1



# JointMaster™ Right Angle Clamping Tools

Large capacity for woodworking!



## PK634

The PK634 has been modified with a larger right angle clamp, it allows for better clamping of 50 x 100 mm wooden studs. Quickly lock and hold stock at 90° angles with a quick clasp of the locking handles.

- Quick single-handed hold & release.
- 40 mm Max clamping capacity.

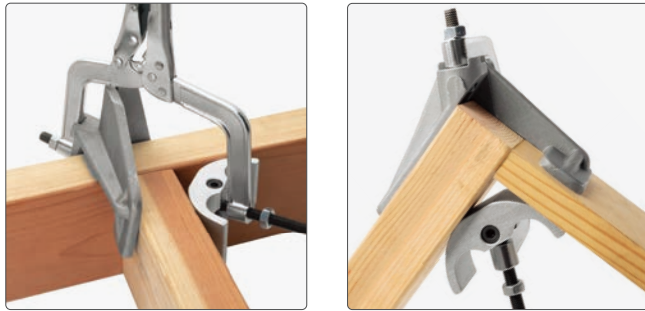

Part No.	A (mm)	B (mm)	L (mm)	Weight (kg)
PK634	40	76	216	0.7

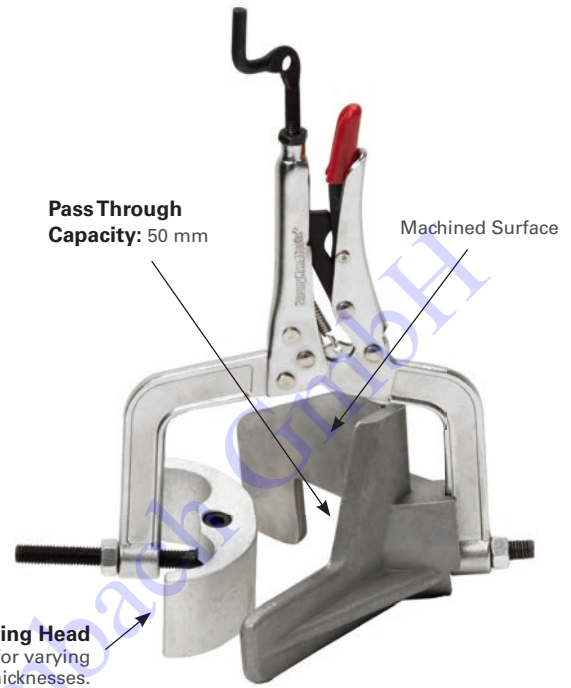

## PLW634

Designed for 90° angle joints of equal stock and features a swivel stop for a quick and easy way of switching the direction of butt joints.

It has a max capacity of 25 mm stock and is ideal for woodworking applications.

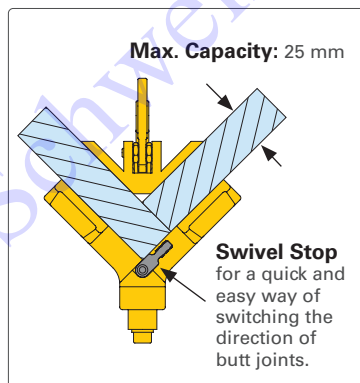

Part No.	A (mm)	B (mm)	L (mm)	Weight (kg)
PLW634	25	76	200	0.6



NEW ITEM



### BENCH-MOUNT PLIERS HOLDER

Convenient storage, or hands-free use

Holds in Vertical & Horizontal positions. Wing nuts on both vertical and horizontal position locks pliers in place.



Part No.	Weight (kg)
PB11	0.1



Use with pliers for long parts.

### CRANK HANDLES

Add the crank handle accessory to the clamps or pliers to:

- Adjust torque with the pliers in the locked position.
- Pre-set the Pliers opening for repetitious clamping applications.
- Loosen the Pliers before unlocking.



U.S. PAT. D763047

Part No.	Thread	For Pliers	Weight (kg)
PXCM6	M6	For 125 mm, 150 mm, 216 mm Pliers	0.01
PXCM8	M8	For 175 mm, 200 mm, 230 mm Pliers	0.03
PXCM10	M10	For 250 mm, 280 mm, 300 mm Pliers	0.08
PXCM12	M12	For 230 mm, 250 mm, 280 mm, 355 mm Pliers	0.10

### SWIVEL / PIVOT PADS

Flat pad pivots at 150° and round pad swivels at 360°.



Part No.	Thread	Height (mm)	Pad OD (mm)	Weight (kg)
854944M (Pivot)	M10	82	Ø44.6	0.09
854940M (Swivel)	M10	66	Ø25.4	0.04

### PLIERS REPLACEMENT PARTS



Part No.	Description	For Pliers	Weight (kg)
PXS11	Spring - 4 per set	280 mm Pliers	0.02
PXS6	Spring - 4 per set	150 mm & 216 mm Pliers	0.01
PXB11	Adjustment Bolt	280 mm Pliers	0.24
PXB6	Adjustment Bolt	150 mm & 216 mm Pliers	0.08

# 2 & 3 Axis Fixture Vises Welders Angle Clamps



Machined welding fixtures made of ductile cast iron.

- Superb Weld Joint Access on all sides.
- Quick Acting Button for fast adjustment (except Model WAC22 and WAC34).
- Copper Plated Spindle Resists Weld Spatter.

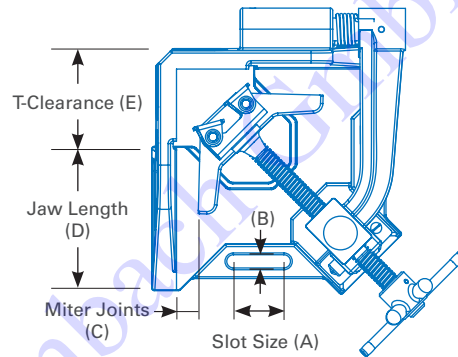
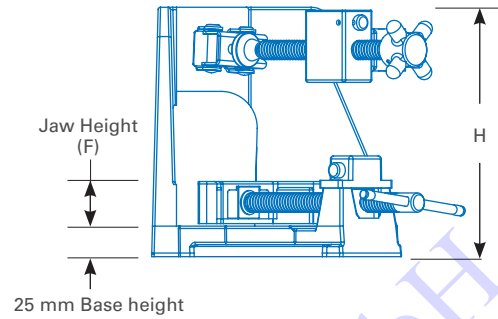
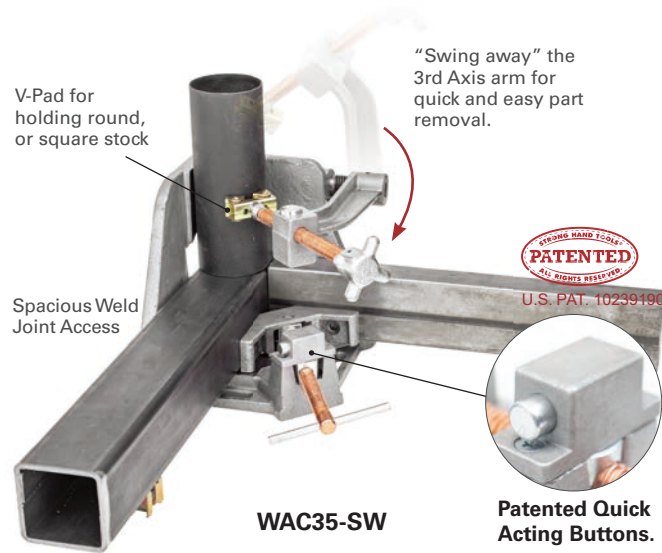

**2 Magnetic Rest Blocks** (included except models: WAC22 and WAC434) to support and level long stock!

**2 Stand-off Bolts** (included in all models) for use with angle iron



Pivoting Head



Angle Iron with Stand Off Feature



T-Joints



Machined Outside Faces for upright joint.

Part No.	2-Axis Vises Features				A	B	C	D	E	F	Weight (kg)
	Quick Acting Button	2x Stand-offs	2x Magnetic Rest Blocks	Machined on Outside Faces	(mm)	(mm)	(mm)	(mm)	(mm)	(mm)	
WAC22		√		√	35.5	11	63.5	80	47	33	2.8
WAC34		√			40	11	95	107	64	35	4.3
WAC35D	√	√	√	√	40	11	95	107	64	35	4.5
WAC45	√	√	√	√	51	11	125	135	103	64	10.0



### 3-Axis Vises Features:

- 2 Quick Acting Buttons
- 2 Stand-off Bolts
- Swing-away Arms
- 2 Magnetic Rest Buttons

Part No.	A (mm)	B (mm)	C (mm)	D (mm)	E (mm)	F (mm)	H (mm)	Weight (kg)
WAC35-SW	42	11	95	120	64	36	210	11
WAC45-SW	51	11	125	135	103	64	245	16

# Welders Universal Vise

Clamp stock at multiple angles.

Clamp stock of different thicknesses at multiple angles. Patented Quick Acting Button for FAST setup!

- Clamp round and square tubing, angled and flat stock at 5° to 180°.
- Copper plated screws with Quick Acting Buttons.
- Individual Angle Clamps easily swivel on the fixture base.



**Jaw Opening:** 100 mm  
**Jaw Height:** 35 mm  
 Malleable Cast Iron

**WAV200**  
Duo Vise



**WAS100**  
Single Vise

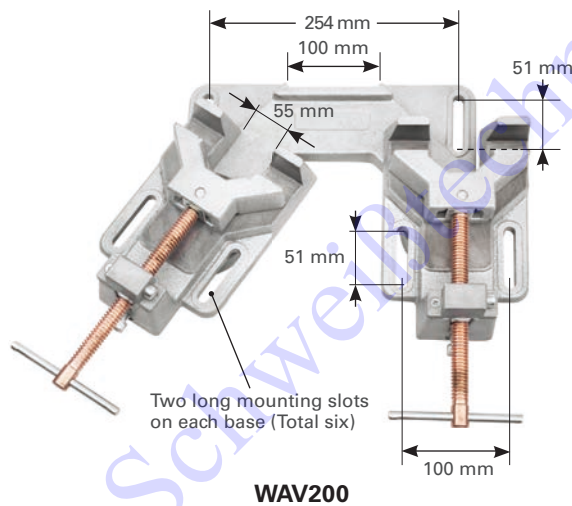
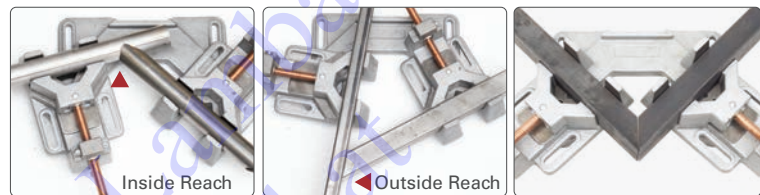

**WAV200**

Press the **Quick Acting Button** to allow the threaded screws to slide in and out for **fast setup**.  
 (Release the button to re-engage the threaded screw for tightening.)

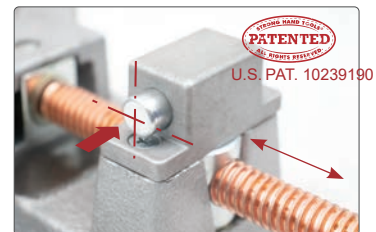

Clamp at **Any Angle** by turning the individual clamps on the fixture base for a wide range of angle settings.

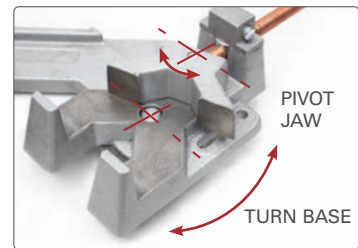

Part No.	Description	Weight (kg)
WAV200	Duo Vise	11.4
WAS100	Single Vise	3.8

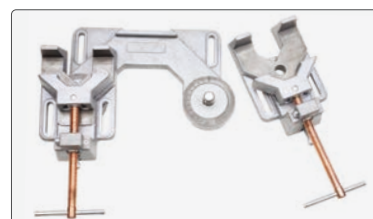

Vises may be removed from the base and used separately.



Use the Magnetic Blocks (included in WAV200) 25 mm, 32 mm and 50 mm heights to support long stock.

# 90° Tru AngL & Portable MagVise™

Time saving aluminum vises for use in the shop and in the field.



## ALUMINUM 90° TRU-ANGL JIG

- Accurate Right Angle Fixture.
- Weld spatter proof aluminum alloy.
- Holds round, square, flat and angled shapes.
- Works on both the outside and inside surfaces.
- Can be held in a vise.

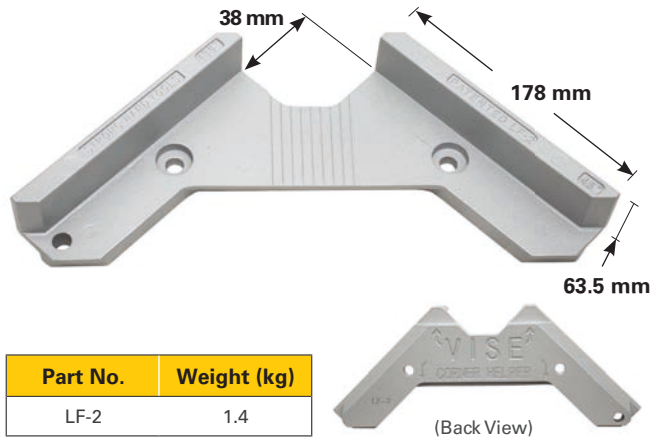

Part No.	Weight (kg)
LF-2	1.4

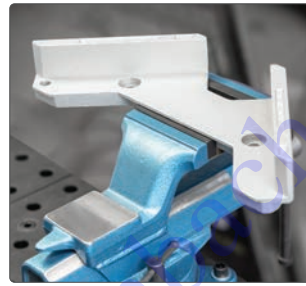
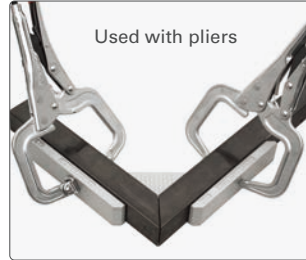

## PORTABLE MAGVISE™

Light weight, die cast and machined vise is packed with features and perfect for tossing into a tool bag.



Press and hold the **Quick Acting Button** and the spindle assembly slides in and out for a super fast set-up!



Clamp jaw pivots to accommodate different thickness.



Magnets in the walls instantly hold pipes, tubes, angle iron, or metal plates in position.

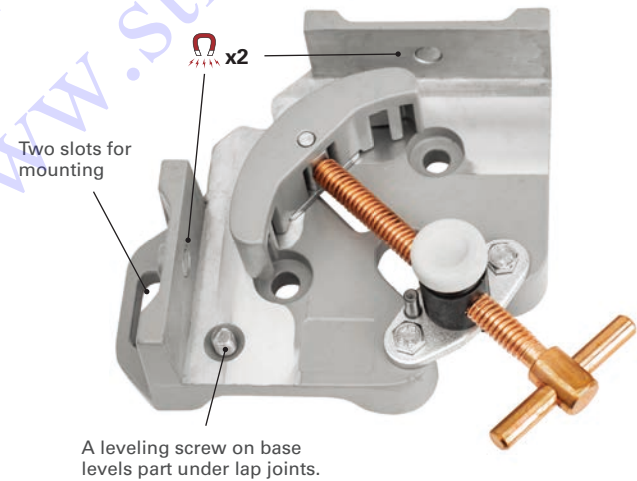

Level parts with screw



Overlap Joint

Part No.	Features	Miter Joints (mm)	Jaw Length (mm)	T-Clearance (mm)	Jaw Height (mm)	Weight (kg)
WK50	Quick Acting Spindle, Magnets, Pivoting Jaw, Machined 90° Angle	25	85	30	51	0.8

# Grounding Magnets, Clamps & Pliers

High clamping force improves arc stability and reduces power consumption.

## POWERBASE™ GROUNDING MAGNETS

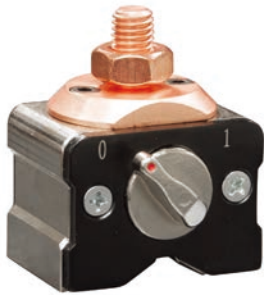

Turn OFF the PowerBase™ Grounding Magnet and metal chips fall away.

Power through your grounding applications! Start grounding instantly!

- The PowerBase™ Grounding Magnet sets up quickly and easily.
- Powerful rare earth magnet delivers heavy duty holding power.
- The "V" machined surface grips round parts.
- The copper connector stud allows for better conductivity.



Large copper connector for better conductivity.



Holds securely onto round or flat surfaces.



The ON/OFF Lever is easy to turn, even while wearing gloves.

Part No.	Amperage	Dimension (mm)	Magnetic Force (kg)	Weight (kg)
GM203	300A @ 60% Duty Cycle	50 x 50 x 64	20	0.5
GM205	500A @ 60% Duty Cycle	50 x 70 x 64	50	0.8

## GROUNDING CLAMP

Clamping + Grounding at the same time.

Consistently rated at 300 AMPS

Solid, insulated copper U-Channel rotates for easy access and can attach to round / odd-shaped parts.

GB428M

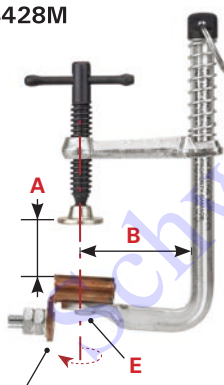

Insulated copper contact swivels



## GROUND HOG™ CLAMP

Insulated Grounding Contact

The groove design on the copperhead seals out weld spatter and reduces particle buildup. Side screw provides a secure cable connection. Ground Hog body rotates for cable positioning.

- Controls the electrical current by isolating the contact surface and the cable connection.
- Improve arc stability and cable life, and reduce power consumption.

GP950

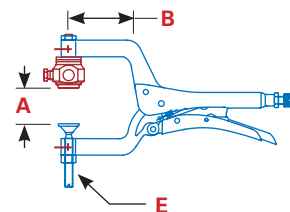

Ground Hog™  
Rated at 450 AMPS @ 60% duty cycle (with 2/0 cable)

Part No.	Amperage / Cable Size	Max. Capacity A (mm)	Throat Depth B (mm)	Tapped Hole E	Clamping Pressure (kg)	Overall Length (mm)	Weight (kg)
GB428M	300A / --	75	64	M6	100	180	0.4
GP950	450A / 2/0 - 10.8 mm	64	89	M10	180	280	1.1

### BIG MOUNT PLIERS W/ COPPER GROUNDING

Large copper contact and opening. Best grounding pliers in the market!

Clamp + Ground thick, thin, and round parts with tight pressure for good contact. Grounding ribbon connects top & bottom jaws.

- Large copper contact, and high clamping force for secure and safe clamping.
- Large range of opening and shape.
- Easy clamping.

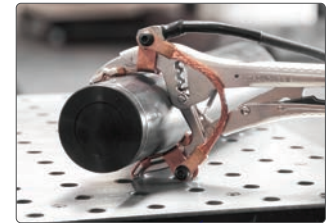
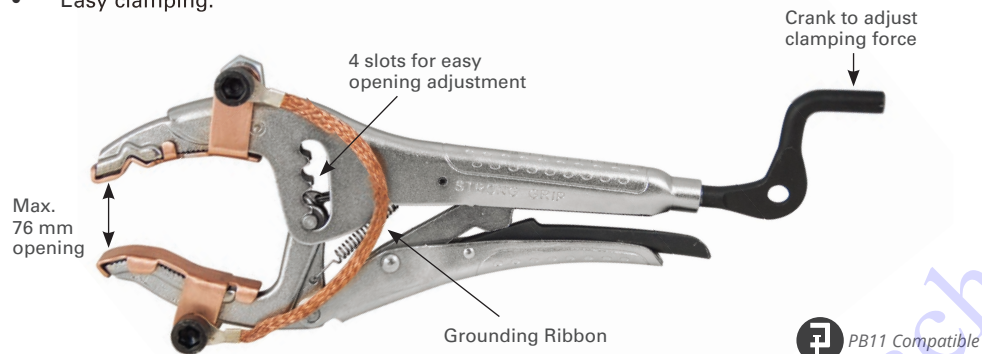

Part No.	A (mm)	B (mm)	L (mm)	Weight (kg)
PAJ207	6 ~ 76	64	250	1.0

\* See page 22 for details of standard Big Mount Pliers - PAJ100.

### GROUND HOG™ UNIT REPLACEMENTS

These are the replacement unit for Ground Hog™ Grounding Pliers and Large Diameter Pipe Grounding Clamps.

The Ground Hog's large copperhead contact point prevents current restriction, allowing a complete transfer of the electrical current in a full circuit. The Ground Hog controls the electrical current by isolating the contact surface and the cable connection. Get a smooth, continuous arc with no fade, and no heat transfer while improving cable life, and reducing power consumption.

Part No.	Replacement for	Amperage / Cable Size	Thread x Length (mm)	Weight (kg)
GC5010	GP950	450A / 2/0	M10 x 30	0.2
GC5310	GP951	530A / 3/0	M10 x 30	0.2



### COPPER SLEEVE REPLACEMENTS

2 pieces per package.

Part No.	For Unite	Inner Dia. (mm)	Height (mm)	Weight (kg)
GXF504	GC5010	11.0	33	0.01
GXF514	GC5310	12.6	33	0.01



# Grounding Magnets

All pure copper contact and links.

## MULTI-ANGLE GROUNDING MAGNETS

The Multiangle Grounding Magnet offers many solutions for grounding applications. Mate connecting pipes and materials at 45°, 30°/60°, 90° or 180° angles while providing grounding.

It features a large, spring-loaded copper springing pad that contacts the mating surface to provide solid ground conductivity.

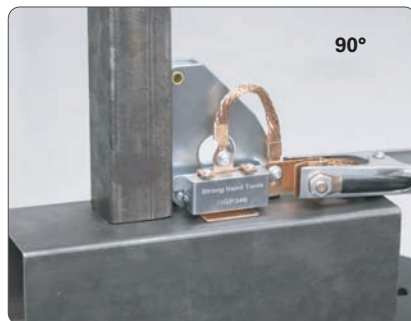

Part No.	Description	Dimension (mm)	Magnetic Force (kg)	Weight (kg)
MGP345	Multi-Angle Grounding Magnet	113 x 98 x 64.5	40	1.00
MGP346	Multi-Angle Grounding Magnet w/ Clamping Pad	113 x 130.5 x 64.5	40	1.05

## MAGNETIC GRASSHOPPER

Magnetic Grounding Grasshopper is a multipurpose tool. It features a magnetic base and adjustable spring clamp to secure components, a handle that facilitates removal, and a 76 mm diameter copper pipe connection with a sliding base support bar.

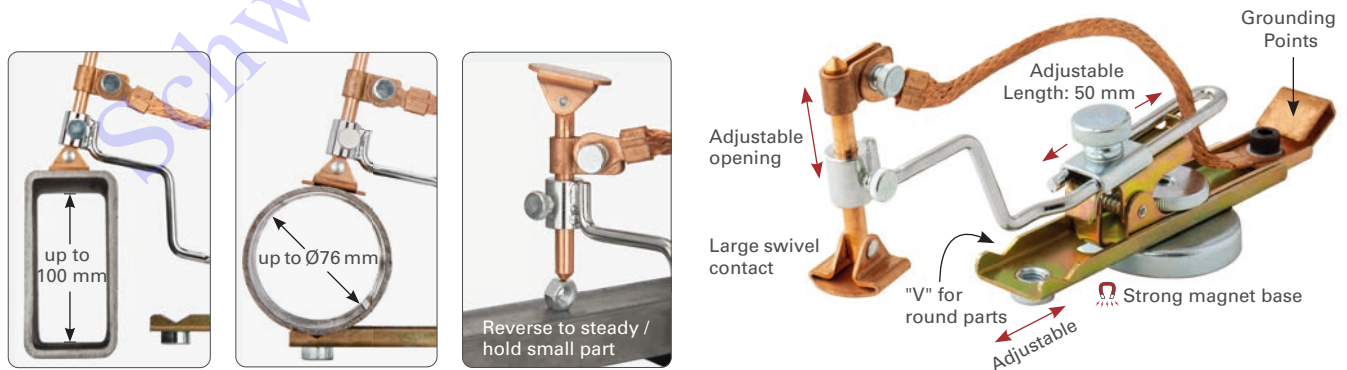

Part No.	Amperage	Max. Overall Length (mm)	Width x Height (mm)	Weight (kg)
MGC150	250 A @ 60%	305	66 x 85	0.8

# Grasshoppers

Use the "third hand" to steady parts for tack welding! Safe and convenient!



## MAGNETIC GRASSHOPPERS

- Spring-loaded arm self-adjusts for **REPETITIOUS WORK HOLDING.**
- Adjustable Copper Spindles (Model AGH240, 270) are ideal grounding contact while Brass Contacts for S.S. jobs. Pinpoint holding provides maximum clearance for tack welds.
- Adjustable V-Pad Base adapts to: round, square, flat, and angled surfaces.
- Anti-tipping Bolt provides stability.

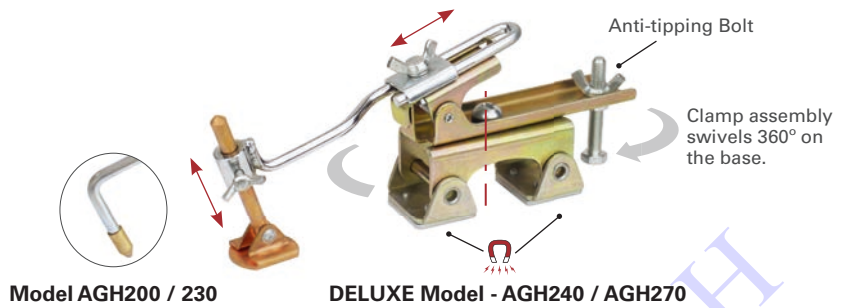

Part No.	Feature	Magnetic V-Pad Base	Anti-tipping Bolt	Max. Overall Length (mm)	Width x Height (mm)	Weight (kg)
AGH240	Copper Spindle	√	√	190	64 x 88	0.4
AGH270	Copper Spindle	√	√	250	100 x 115	0.8
AGH200	Brass Contact	√	√	203	64 x 76	0.3
AGH230	Brass Contact	√	√	234	100 x 100	0.6

## STANDARD GRASSHOPPERS

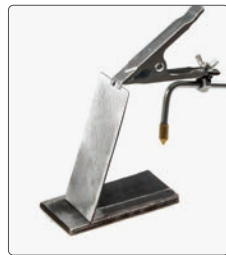

Pro Model - AGH130P



Econo Model - AGH130



Part No.	Product Includes	Max. Overall Length (mm)	Width x Height (mm)	Weight (kg)
AGH130P	Three Brass Contacts, Copper Ribbon, Spring Clip Attachment	300	114 x 100	0.7
AGH130	Brass Contact	300	114 x 100	0.7

## HOLE PLUG MAGNET

- Fast and easy hands free tool for plug welds.
- Pivoting magnetic base adapts to curved steel panels.
- Copper backing pad prevents weld from sticking to the tool.

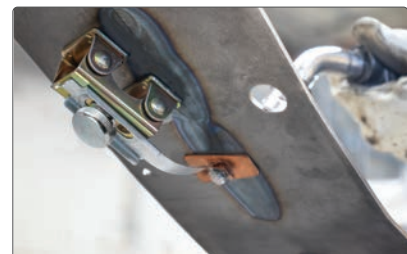
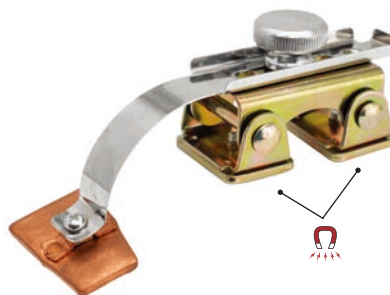

Part No.	Description	Dimension (mm)	Weight (kg)
AGK320	Hole Plug Magnet	140 x 40 x 46	0.18
AGK450	Hole Plug Magnet, Large	225 x 53 x 94	0.55

## ARTICULATED ARM REST

This fully adjustable Arm Rest with the fully articulated arm, supports your extended arm while working. Steady your arm or hand, for greater weld control and reduced fatigue.

The 2-section Articulated Arm is height adjustable [slide up or down the support column] and swivels quickly and easily for work in precise locations. The comfortable, generously sized arm cup turns in a 360° arc for complete freedom in positioning, and instant re-positioning.

Place the sturdy, anti-tipping, magnetic base plate on any steel surface and level by adjusting the two leveling bolts.



**ARA18**

Part No.	Overall Height (mm)	Articulated Arm Height Range (mm)	Articulated Arm Reach (mm)	Weight (kg)
ARA18	380	150 ~ 380	0 ~ 320	2.5

## ADJUSTABLE WRIST REST

This fully adjustable Wrist Rest has solid steel construction for durability and optimal stability. "Carry" your MIG or TIG torch smoothly along the 280 mm travel length of the Stainless Steel Rest Bar.

The Rest Bar is height adjustable [slide up or down the support column]. Place the sturdy, anti-tipping, magnetic base plate on any steel surface and level by adjusting the two leveling bolts. For space-saving storage, remove the Rest Bar from the adjustment column for vertical docking. An important addition to any welding setup. Steady your wrist for accurate welding and greater work quality with less fatigue.

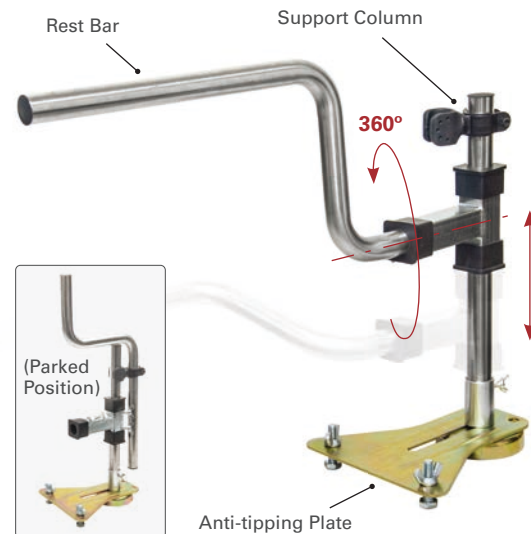

**ARW16**

Part No.	Overall Height (mm)	Rest Bar Height Range (mm)	Rest Bar Length (mm)	Weight (kg)
ARW16	470	0 ~ 470	280	2.8

# Grinder Rests

Time saving magnetic tools for use in the shop & in the field.



Store your Grinder and all accessories on one convenient, compact, portable rest for easy access. The Grinder Rest holds most 125 mm Grinders. No more searching for wrenches or spare discs!

## MAGNETIC BASE MODEL



Super strong magnetic base mounts securely to any steel surface.



Store Wrench



Hold Disc



Cable Wrap Hook

## C-CLAMP BASE MODEL



### Adaptor Plate

\* Includes Adaptor Plate for table leg and beneath table edge Mounting!



Part No.	Description	Weight (kg)
MGH4510	Magnetic base model	1.1
MGK53	C-Clamp base model w/ Adaptor Plate	1.0

## READYREST 180 MM GRINDER REST

Store your costly 150 mm or 180 mm Grinder on this New Grinder Rest to prevent damage, maximize valuable space, and create an organized work area.



\* Pliers, Torches and Grinders shown are not included.

Part No.	Description	Weight (kg)
MGH600	Grinder Rest with Adjustable Cable Hanger, Anti-tipping Plate with Part Storage, Height & Angle Adjustable	2.7

## MIG TORCH RESTS

**MRM100** is Basic Model includes Adjustable Cable Hanger, Angled anti-spatter Gel Pot and two Pliers parking slots (MIG Pliers sold separately)

**MRM200** is Height and Angle Adjustable.

**MRM300** is Deluxe Model includes Park N' Snip feature. Cut your MIG wire to the ideal length without taking off your gloves! Get a precise cut every time, without guesswork. Insert your MIG Pliers through the two slots, rest your nozzle on the parking plate, and snip. Now you can easily trim the wire to the ideal length for better weld control.



\* Pliers, Torches and Grinders shown are not included.



**Cut your MIG wire to the ideal length without taking off your gloves!**  
Get a precise cut every time, without guesswork. Insert your MIG Pliers through the two slots, rest your nozzle on the parking plate, and snip. Now you can easily trim the wire to the ideal length for better weld control.

Part No.	Height and Angle Adjustment	MIG Torch Rest includes	Height (mm)	Weight (kg)
MRM100	Fixed	Cable Hanger & Accessory Plate	150	1.0
MRM200	Adjustable	Cable Hanger & Accessory Plate	180 ~ 310	1.5
MRM300	Adjustable	Cable Hanger & Deluxe "Park N' Snip" Accessory Plate	180 ~ 310	1.8

## MIG PLIERS

**Multi-Functional and unique!**

**PM25** pliers feature a slag-hammer chipper side for eliminating welding leftovers, a flat hammer with a scraper edge for fast spatter removal, and an induction-hardened cutting edge, chipper edge, and scraper edge.

**PM12** includes a fine/coarse file, flat/rounded hammer, V-Notch for wire/nuts, a comfortable grip, and a retention chain that attaches to MIG Gun Holders.

**PM08** is spring-loaded for one-handed usage and has vinyl-coated handles for secure gripping, and a hammer for light welding gun maintenance.



**PREMIUM MODEL - PM25**



**DELUXE MODEL - PM12**



**STANDARD MODEL - PM08**



Part No.	Overall Length (mm)	Files	V-Notch	Hammer	Retention Chain	Weight (kg)
PM25	215	Fine & Coarse File	✓	Flat face and chipper side	✓	0.5
PM12	215	Fine & Coarse File	✓	Flat and rounded face	✓	0.4
PM08	215	Coarse File	-	Rounded face	-	0.3

## TIG TORCH RESTS

You don't work in one fixed position, so neither should your torch rest.

The height and angle adjustable ReadyRests attach securely to any steel surface for safe and convenient holding of your torch and cable for full access while you work. The unique adjustable cable hanger provides cable control for safety, and ease of handling.

Store your torch on the ReadyRest to prevent damage and create a clean, organized work area.

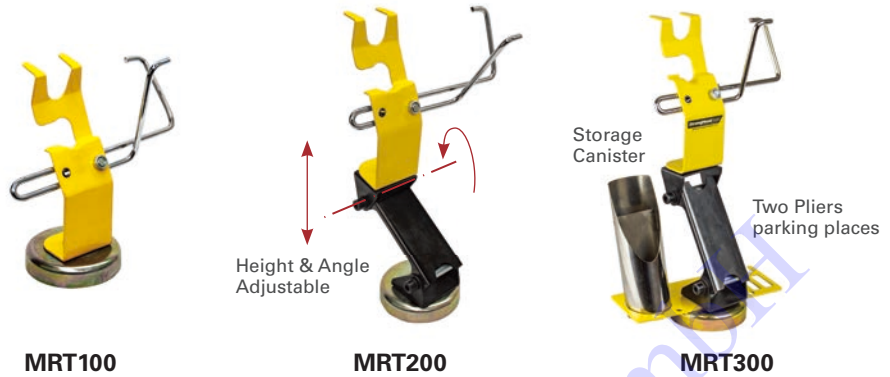

Part No.	Height and Angle Adjustment	MIG Torch Rest includes	Height (mm)	Weight (kg)
MRT100	Fixed	Cable Hanger	190	0.9
MRT200	Adjustable	Cable Hanger	180 ~ 310	1.3
MRT300	Adjustable	Cable Hanger and Accessory Plate with Canister	180 ~ 310	1.6

## TABLE EDGE TIG REST

The most space-saving model in the ReadyRest™ line!

When every inch of space on your work surface is utilized, the Table Edge Torch Rest holds your torch at the table edge, out-of-the-way, yet easy to access quickly.

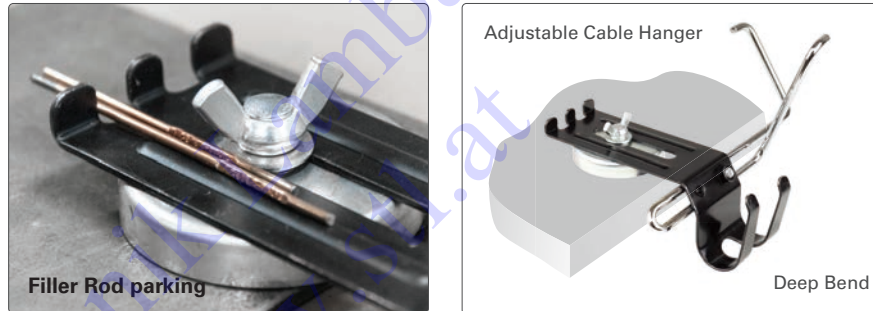

Part No.	Description	Height (mm)	Weight (kg)
MRT50	Table Edge Mount TIG Torch Rest with Cable Hanger	140	0.5

## UNIVERSAL RESTS

MIG, TIG, Electrode holder...ONE SIZE fits ALL

The Universal Rests hold your MIG or TIG Torch, or Electrode Holder. The Stainless Steel housing is angle-adjustable, with an adjustable keeper plate inside for secure, customizable holding.

Position and store your MIG, TIG torches and Electrode Holder securely and conveniently for easy access, and to prevent damage to gun and tips.

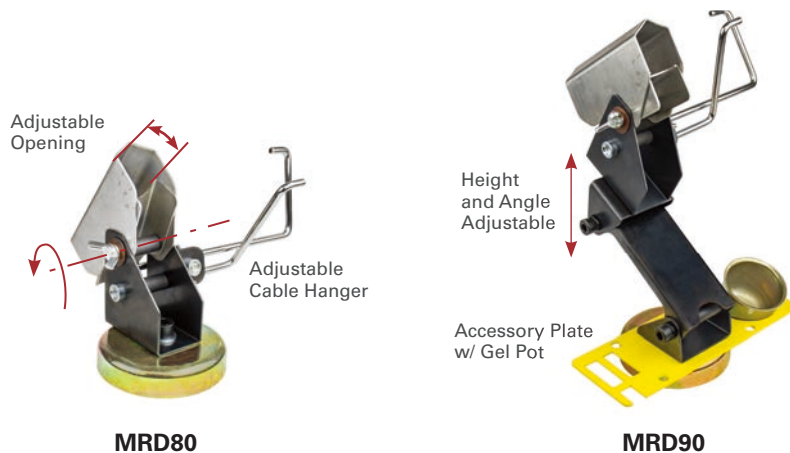

Part No.	Height and Angle Adjustment	Universal Rest includes	Height (mm)	Weight (kg)
MRD80	Fixed	Cable Hanger	150	1.1
MRD90	Adjustable	Cable Hanger & Accessory Plate	180 ~ 310	1.8

# TIG Feeders & TIG Part Organizer

Time saving magnetic tools for use in the shop & in the field.

NEW ITEM

## TIG FEEDERS

Smoothly feed TIG wire for total control and accuracy, at the ideal distance, for higher quality welding, even with gloves on! Minimize filler wire waste.

- Compact, lightweight Feeder rests securely, comfortably in your hand.
- Easily customizable to set wire tension and control.
- Reduce fatigue to help prevent carpal tunnel syndrome.
- Stainless Steel.

ATF200 comes with a magnetic base and a thermal shield.



Lightweight Feeder rests securely, comfortably in your hand.



Compact Magnetic Base and Thermal Shield on Model ATF200

Part No.	Dimension (mm)	Weight (kg)
ATF100	178 x 76 x 25	0.07
ATF200	178 x 89 x 89	0.14

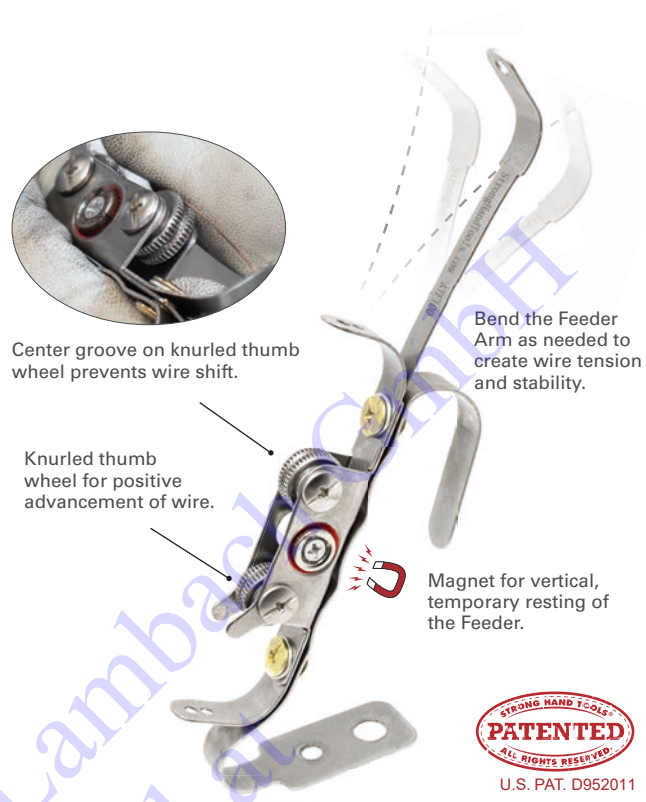

## TIG PART ORGANIZER

Store your most frequently used TIG Accessories on the 228 x 127 x 50 mm TIG Part Organizer for easy access.

A total of 25 cavities hold back caps, ceramic cups, glass cups, collets, and collet bodies.

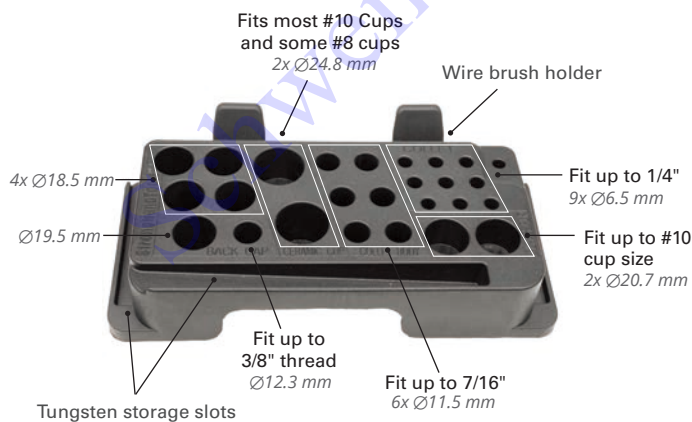

2x Removeable magnets at the bottom

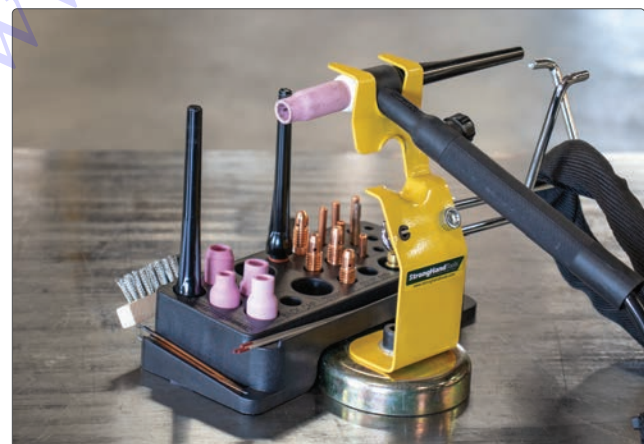

Slotted base for space-saving use with the ReadyRest TIG Rest, PN MRT100 [sold separately]

Part No.	Description	Weight (kg)
ATT180	TIG Part Organizer	0.3
ATTF200	1x TIG Feeder + 1x TIG Part Organizer	0.4

# TIG Feeder Stand & Magnetic Panel Holder

Time saving magnetic tools for use in the shop & in the field.



## TIG FEEDER STAND W/ MAGNETIC BASE

Mount the TIG Feeder on this New Adjustable Stand to create a Modular Feeder System. Increase weld accuracy and reduce fatigue to better accommodate the demands of your production environment. Achieve precision placement and greater accuracy not possible with the handheld method.

Place the compact, universal Magnetic Base at any point on your steel work surface, even in tight spaces.

Set the Stand at the ideal height and angle required for each job; Min. 3" / 7.6 cm, Max. 10" / 25 cm height adjustment.

Mount the TIG Feeder, PN ATF100 [sold separately] onto the pivoting head, position the adjustable 2-section arm as required, and lock into position by tightening the screws.



Part No.	Description	Dimension (mm)	Weight (kg)
MTH800	TIG Feeder Stand w/ Magnetic Base	203 x 76 x 50	0.5

## MAGNETIC PANEL HOLDERS

Quickly set up free-standing aluminum, steel or plexiglass panels in any configuration for safety at welding stations or other work environments.

Protect workers, materials, and equipment from the hazards of welding sparks, spatter, welding flash, gases, sun glare and wind.

- 140 mm H "clip style" Holders support panel thicknesses up to 10 mm. No tools required.
- Strong magnetic base for secure placement on any steel surface.
- Secure right angle setups with 2 pcs. Right Angle Fixtures (incl. in AWS120 only).
- Use additional Panel Brackets to partially or fully enclose the work area as needed.



AWS120

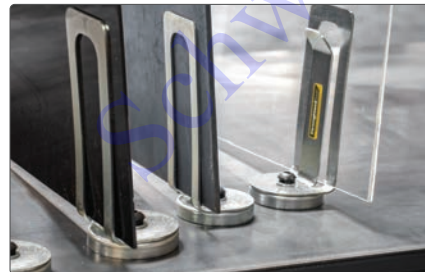

140 mm H "clip style" Holders support panel thicknesses up to 10 mm.



Create a safer work environment by easily setting up protective panels wherever needed, in the shop or out in the field.

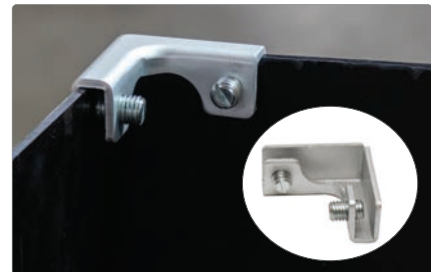

Create a 90° panel setup with the Right Angle Brackets [2 pcs. incl. in AWS120 only]

Part No.	Description	Weight (kg)
AWS100	2x Magnetic Panel Holder	0.9
AWS120	6x Magnetic Panel Holders + 2x Right Angle Brackets	2.5

# Chisels, Hammer Extensions

Faster pre and post weld cleaning.

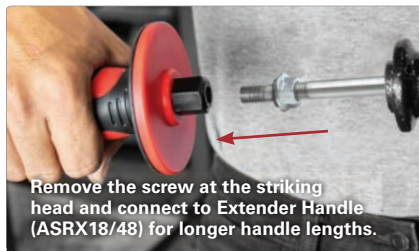

The Chisels can be connected to the sliding hammer (ASRX18) for tabletop height use.



The built-in sliding hammer enables odd direction/position hammering.

Part No.	Length (mm)	Weight (kg)
ASRX18	510	1.2



Adding the extension and handle (ASRX48) extends its applications to scrapping/chiseling spots on the floor or on high location.

Part No.	Length (mm)	Weight (kg)
ASRX48	610	0.9

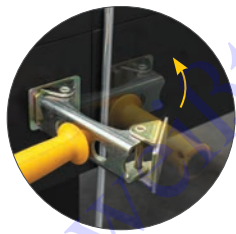

Part No.	Description	Weight (kg)
ASR100	Pointed Chisel	0.9
ASR110	1" Flat Chisel	0.9
ASR120	2" Flat Chisel	0.8
ASR140	4" Flat Chisel	0.8

**ASR SERIES CHISELS**

# Magnet with Handle

Quick-set hold down clamps.



## SHEET METAL MAGNETS

Hold sheet metal and automotive metal panels firmly in a positive location for cutting, welding, tacking, painting and repair operations.

Rare earth disc magnets in the magnetic plate have superior gripping power. Rubber Pads on the Sheet Metal Magnets provide friction for increased drag force in sheet metal handling applications.

Use horizontally or vertically. The strong, generously sized plastic handle makes placing, moving, and removing the Sheet Metal Magnets fast and easy.

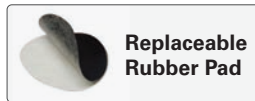

Part No.	Description	Straight Pull Force (kg) *	Side Drag Force (kg) *	Weight (kg)
MCB82	Heavy Duty Sheet Metal Magnets	45 / ea.	20 / ea.	0.55
MCB802	10 pcs. Replaceable Rubber Pad	--	--	0.05

\* Subject to surface thickness and texture.

## LARGE MAGNETIC V-PADS

Hold and position steel stock at any angle in fixturing, welding, inspection and repair applications.

Four rare earth magnets in each pad provide secure gripping power for rapid and convenient holding and positioning.

Pads pivot to hold onto round, square or flat metal surfaces.

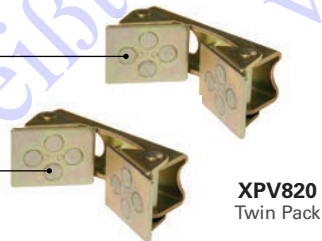

XPV820  
Twin Pack



Large, removable comfort handle for control in placing, positioning and removing the clamp.

The adjustable magnetic V-Pad is easy to remove. Pull back firmly on the handle to break the magnetic force.

Protective Rubber Pads included.



XPV830

Part No.	Description	Dimensions (mm)	Max. Pull Force (kg)	Weight (kg)
XPV820	Large Magnetic V-Pad, Twin Pack	120 x 50 x 48	26 / ea.	0.9
XPV830	Large Magnetic V-Pad w/Handle	120 x 50 x 158	26	0.6

# MagLevels

## Magnet Layout Tools

### EZ-VIEW 3-AXIS LEVEL

- Three built-in jumbo Vials and one large 1 Plug Vial.
- The large plugin Vial rotates for comfortable viewing angle and lets you check level in two axes at same time.
- Large machined edge guide for easy alignment to large parts.
- CNC machined for accuracy. Anodized aluminum body.

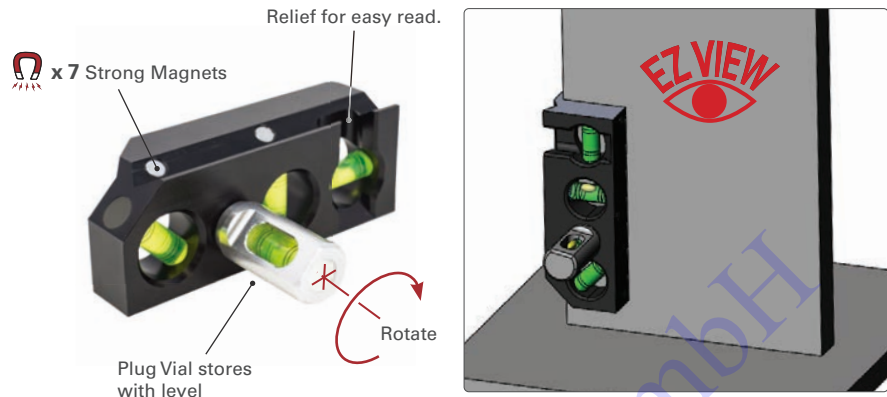

Part No.	Dimensions (mm)	Weight (kg)
LM4625	152 x 45 x 55	0.5

### MAG-LEVEL

The only magnetic level with the On/Off switch.

Holds securely to round and flat surfaces.  
Three vials for 0°, 45°, 90° reading.

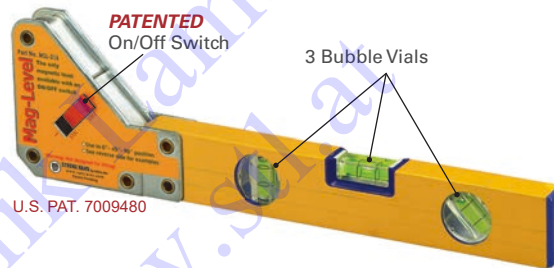
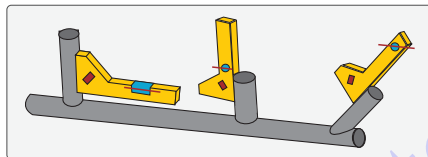

Part No.	Angles	Dimension (mm)	Max. Pull Force (kg)	Weight (kg)
MSL-316	45°, 90°, 180°	100 x 405 x 25	30	0.9

### EZ VIEW CONDUIT LEVEL

- **STRONG MAGNET** provides secure attachment on conduits or structural parts at fixed angles.
- Place at ANY point on CONDUIT for convenient readings!
- Two easy to read JUMBO high visibility vials for checking 30° / 60°, 45° and 90°.
- Rugged construction.



Part No.	Angle	Dimensions (mm)	Weight (kg)
LMC34679	30° / 60°, 45° and 90°	86 x 76 x 43	0.4

# Leaf Spring Clamps & Magnetic Welding Gauge

Fast and easy hands free tools!



NEW ITEM

## LEAF SPRING CLAMPS

The Leaf-Spring Clamp has a simple but effective design that lets you quickly clamp down on workpieces.

The clamping component functions like a leaf spring to apply force and is height and force adjustable by compressing the spring locking mechanism along the shaft; it can be rotated a full 360° and flipped upside down to act as a push clamp.

They are designed for light clamping applications and feature a v-grooved copper contact pad.



MEC100 has a magnetic V-Pad base for mounting on square or round tubing or uneven surfaces.

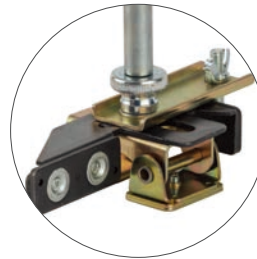

MEH25 features a MagTab base for mounting on square or round tubing or uneven surfaces with additional magnetic planes for mounting stock materials.

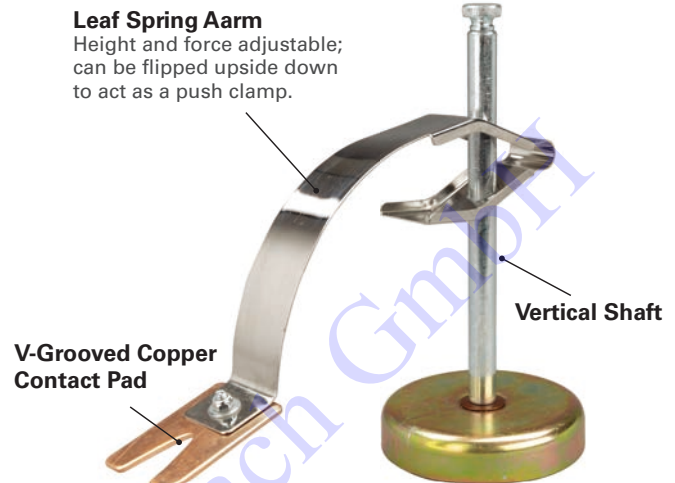

**Leaf Spring Aarm**  
Height and force adjustable; can be flipped upside down to act as a push clamp.

**Vertical Shaft**

**V-Grooved Copper Contact Pad**

Model MCC90 has a magnetic base for attaching to flat metal surfaces and a vertical shaft holding the clamping arm.

Part No.	Base	Dimensions (mm)	Weight (kg)
MCC90	Magnetic Base	227 x 90 x 190.6	0.9
MEC100	Magnetic V-Pad w/ Anti-tipping Plate	250 x 65 x 160.6	0.5
MEH25	MagTab w/ Anti-tipping Plate	250 x 70 x 178.6	0.5

## MAGNETIC WELDING GAUGE

The MVS150 is a thickness gauge featuring a magnetic V-Pad base. The feeler gauges are attached to a rotating arm providing convenience and versatile positioning. The rotating arm makes it easy for positioning adjustments. Opposite of the V-pad is a suction cup for mounting to smooth surfaces.

Measure gaps from 0.5 mm to 7 mm, gauge sets are 4x 0.5 mm, and 5x 1 mm.

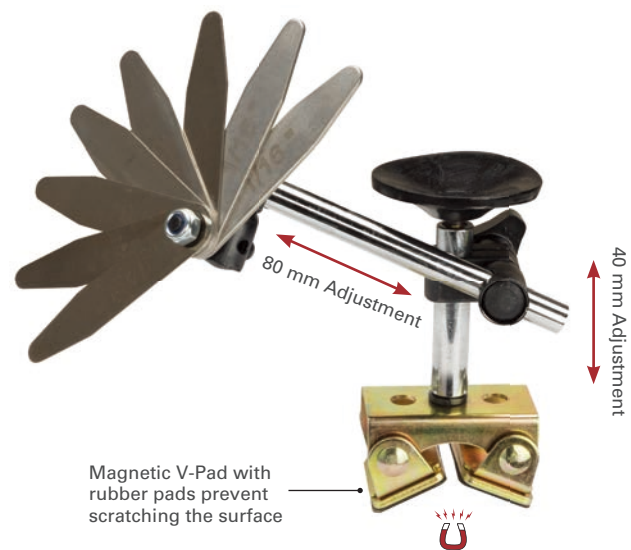

Magnetic V-Pad with rubber pads prevent scratching the surface

Part No.	Dimensions (mm)	Weight (kg)
MVS100	175 x 145 x 65	0.5

NEW ITEM

# The Third Hand Modular Clamps

FULLY articulated, FULLY adjustable.

## PORTABLE 3-AXIS CLAMP KIT

Kit includes: Spring Loaded L Clamp w/ 3-Axis Bracket + Pipe Pliers

- Light and easy to use. Set up 3-Axis stock before tack welding.
- Wide opening provides unobstructed welding access.
- **Pipe Pliers [included]** holds 3-axis stock in position; 38 - 64 mm capacity. 216 mm Overall Length.

Part No.	Kit includes	Weight (kg)
UDL365K	1x UDL365 1x PG635V	1.4

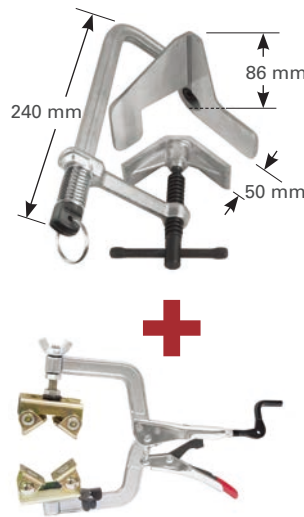

## THE THIRD HAND MODULAR CLAMPS

"Third Hand" positions your workpiece at any angle for full weld access. Use your THIRD HAND to elevate and firmly hold stock at the ideal angle and height while you weld, cut, sand or paint.

Securely hold stock at any position with ball joint adjustment and locking.

- **Universal clamp base (HAS42)** mounts on flat or square surfaces (up to 50 mm thick), angle iron, and 25 mm round posts.
- **Two hole clamp base (HAS40)** is compatible with Rhino Cart® and BuildPro® Welding Tables for mounting at any point on the tabletop.
- 19 mm opening Slotted Adaptor Head accepts Pliers or Clamps to hold round, flat, square or angled stock. Two screws securely hold parts or clamps in position.



Universal Clamp Base Model  
**HAS42**

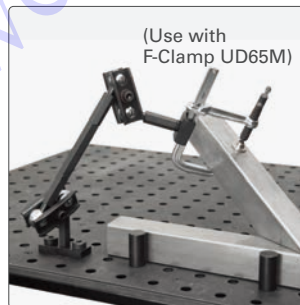

Welding Table Base Model  
**HAS40**

Part No.	Description	Weight (kg)
HAS42	Universal C-Clamp Base Model	1.1
HAS40	Welding Table Base Model	1.6

# MagHold™ Extendable Arm & Snake Magnets

Time saving magnetic tools for use in the shop & in the field.



## MAGHOLD™ EXTENDABLE ARM

Position and hold steel stock in welding and fabrication.

Telescoping mounting bar adjusts from 163 mm to 238 mm in length.

Loosen the center joint in the mounting bar to "fold up" the MagHold™ for different workholding configurations.

Adjustable magnetic V-Pads at each end hold stock of different shapes: round, flat, angled.



Part No.	Max. Pull Force (kg)	Weight (kg)
MHF608	8	0.6
MHN610	12	1.2

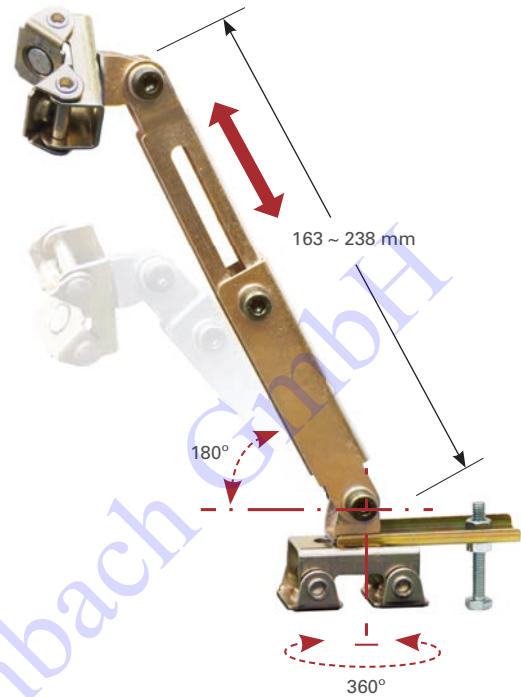

## SNAKE MAGNETS

The Third Hand - Holds, Bends, Twists

The Snake Magnet gives you the flexibility to hold stock at odd angles. MFC312 has two magnetic V-Pads that are adjustable for different shapes: round, flat, angle metal surfaces. Both models have Spring Clamp that can be used as the third hand to hold tools.



Part No.	Description	Weight (kg)
MFC312	12" flex cable, 1 clamp, 2 Adjustable Magnetic V-pads	0.5
MFC318	18" flex cable, 1 clamp, 2 flat Magnetic Pads	0.6

# Table Mount, Drill Press, Half & Hold Down Clamps

Quick-set hold down clamps.

## TABLE MOUNT LOCKING C-CLAMPS

Mounts directly to any work bench, drill press and fixtures.

- Mounting base hole accepts standard M8 bolts and uses push-down action to hold your workpiece securely.
- Use the Crank-Handle for pressure adjustment.
- Rapid lock and release. Ideal for repetitious clamping.

Part No.	A (mm)	B (mm)	Mount Thread	Weight (kg)
PT11	100	86	M8	0.7
PT14	120	155	M8	0.9

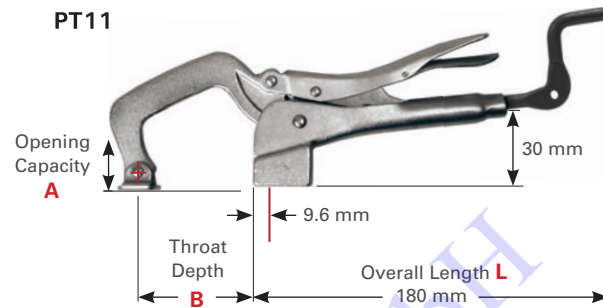

## DRILL PRESS CLAMP

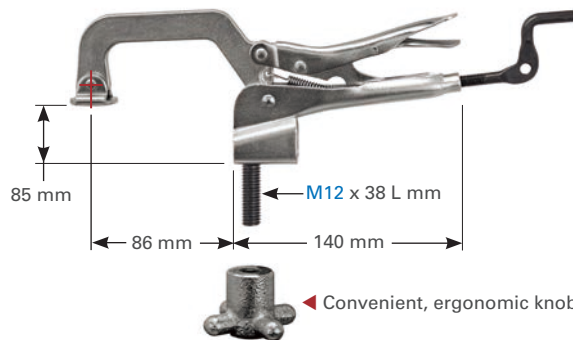

Quickly locks and releases make them ideal for repetitious clamping. Secure the Drill Press Clamp to any surface, up to 25 mm thick.

Part No.	Weight (kg)
PTD09	0.9



## HALF CLAMP

The Efficient, Safe Way to Align Materials.

The DOG & WEDGE and CUT-OFF C-CLAMP methods of material alignment are messy, time consuming, and unsafe!



U.S. PAT. 6983525

Part No.	Weight (kg)
VHC15	2.2



## HOLD DOWN CLAMP

Bolt the clamp down to your worktable using the Ø10.5 mm hole in the base.

- The 12.5 mm copper plated Acme spindle resists weld spatter, and the swivel tip makes quick contact with your workpiece.
- Hold pipes by adding our Clip-On V-Pad, Part No. XDA2. (See page 9 for details.)



Part No.	Weight (kg)
VHD30M	0.9

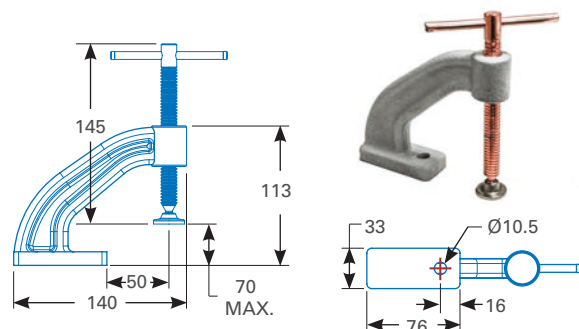

# Platen Clamps

Platen and Universal Tabletop Clamps.



## MODULAR PLATEN CLAMPS

For fast, secure clamping, simply insert the clamp into the 44 mm square hole in your acorn platen. Slide the clamp arm down to the work piece and turn the T-Handle to tighten.

Clamp comes with standard or heavy duty Swivel Pads.



Compatible with clamp accessories such as Sidekick and Top V-Pad.



Part No.	Rail Size	Pad	Opening Capacity (mm)	Throat (mm)	Weight (kg)
UF12NA	"F"	Standard	305	120	2.4
UM12NA	"M"	HD	305	140	3.6
UM16NA	"M"	HD	406	140	4.0
UM20NA	"M"	HD	508	140	4.4



A photograph of a workshop. In the background, a dark car is elevated on a blue Challenger lift. In the foreground, a red gas cylinder is mounted on a yellow trolley. To the right, a black Nomad workbench with a stainless steel top is on wheels. The scene is filled with various tools and equipment.

# Shop Equipment and Organization

We are excited to expand our offerings outside of the clamping and hand tool space to create a new Shop Equipment and Organization category to further our mission of helping fabricators work more comfortably and efficiently.

# Tool Pouches

Keep your tools organized.



## TOOL POUCHES

Strong and durable tool pouches have 5 pockets that open at the top to accept tools, parts, and supplies.

The additional measuring tape clip at the front and a keep magnetic bar at the bottom for small tools or screws your tools organized and easy to reach.

MPT100 features the additional round screw magnet to secure all your small nails, screws, or nuts while working.



**Durable Belt**  
adjusts from 1 m to 1.3 m

**MTP50**



**MTP100**

Part No.	Description	Weight (kg)
MTP50	Tool Pouch Only	0.27
MTP100	Tool Pouch w/ Screw Magnet	0.36
MHC50-2PK	Screw Magnet, Twin Pack	0.18



**MIG Pliers (PM25)** fit comfortably in the tool pouch and the retention chain attaches to the tool clip to prevent loss.

# Pipe Marking Tools

Time saving magnetic tools for use in the shop & in the field.

NEW ITEM

## ROUND CONTOUR MARKER

Mark accurate straight lines on pipes and curved surfaces with the Round Contour Marker, a unique tool designed to simplify your line-marking tasks and deliver impeccable results every time. Whether you're a professional tradesperson or a DIY enthusiast, this tool will become an essential part of your marking toolkit.

- Magnet Base with On/Off Switch
- Integrated Leveling Dial
- Adjustable Marking Line Angle
- Versatile Contour Marking
- Durable Construction
- User-Friendly Design

Part No.	Case Dimensions (mm)	Weight (kg)
RCM100	340 x 280 x 127	3.3



NEW ITEM

## ROUND HOLE MARKER

Crafted from premium anodized aluminum, the Round Hole Marker is the ultimate tool for accurate and effortless hole marking.

- Switchable On/Off Magnet
- Adjustable Extension Arm
- Versatile Angle Adjustment
- Elliptical Markings
- Durable Anodized Aluminum

Part No.	Case Dimensions (mm)	Weight (kg)
RHM200	430 x 368 x 107	5.1



NEW ITEM

## MAGNETIC PIPE CENTERING HEAD

The Magnetic Pipe Centering Head is the perfect tool for marking pipes above 50 mm in diameter. Designed to precisely mark center points both on the interior and exterior of pipes.

Crafted from high-quality anodized aluminum, the adjustable dial bubble protractor takes accuracy to a new level. Graduated in 2.5° increments, it ensures precise measurements.

The 360° rotatable degree dial boasts an integrated vial, guaranteeing level accuracy. Additionally, integrated magnets allow this tool to effortlessly secure itself at any desired angle on steel pipes.

Part No.	Fit Pipes (mm)	Dimensions (mm)	Weight (kg)
MPCH250	Ø50 and up	112 x 152 x 36	0.7



# TIG Tungsten Stick-out Gauge & Pole Magnetic Part Picker

Time saving magnetic tools for use in the shop & in the field.



## TIG TUNGSTEN STICK-OUT GAUGE W/ MAGNETIC BASE

Enhance your welding precision and efficiency with the Tungsten Pro-Gauge, Round. Made from durable aluminum, this compact device is your indispensable companion for achieving consistent and accurate tungsten rod protrusion distances tailored to diverse welding applications and specifications.

- Rotating Dial for round model and Gauge Grid for square model
- Ease of Use
- Durable Aluminum Construction
- Enhanced Weld Quality
- Time and Cost Savings



Part No.	Type	Dimensions (mm)	Weight (kg)
ATG127	Round	76 x 76 x 76	0.3
ATG227	Square	90 x 76 x 76	0.3

NEW ITEM

## ON/OFF MAGNETIC PART PICKER

The Magnetic Part Picker – your reliable partner in efficient part retrieval. Whether you're a professional, a DIY enthusiast, or anyone who works with small metal components, this tool is designed to simplify your tasks and enhance your overall experience.

- Powerful Switchable Magnet
- Extended Reach
- Robust Lifting Capacity
- Pivoting Head
- Premium Build



Part No.	Dimensions (mm)	Weight (kg)
MPD40	1,049 x 190 x 76	1.4

NEW ITEM

# Cylinder Valve Indicators & Gas Flow Meter

Essential tools for handling gas.

NEW ITEM

## EZ-VIEW GAS CYLINDER VALVE INDICATORS

Made from ABS plastic, EZ-View design allows you to quickly glance to see if gas has been left on from a distance.

Money saver: reduce waste of gas from cylinders accidentally left on.

Simple installation: quickly snaps on and off valves.

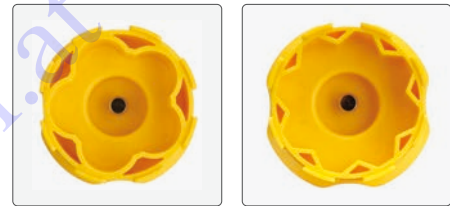

Part No.	Fit Handwheels	Dimensions (mm)	Weight (kg)
GVC330	3 stars	85.6 x 85.6 x 47.5	0.1
GVC300	5 stars	85.6 x 85.6 x 47.5	0.1
GVC380	8 stars	85.6 x 85.6 x 47.5	0.1

NEW ITEM

## GAS FLOW METER

Your essential tool for precise gas flow control in shielding gas applications like MIG and TIG welding.

- Pinpoint Accuracy: Ensure precise gas flow measurement for superior weld quality and less waste.
- Easy Compatibility: Designed for argon and carbon dioxide use, perfect for MIG and TIG welding.
- User-Friendly: Intuitive interface for effortless setup and monitoring, suitable for all skill levels.
- Built to Last: Durable construction to withstand industrial environments, ensuring reliability.

Part No.	Dimensions (mm)	Weight (kg)
GFM404	78 x 58 x 148	0.05



# Gas Grabbers & Adjusta Gas Cylinder Storage Hook

Essential equipments for handling gas cylinders!



NEW ITEM

## GAS GRABBERS

Safely and easily lift, transport, and place gas cylinders around the shop with the Gas Grabber.

Reduce back strain and increase shop safety.

- Automatic cylinder engagement
- 120 kg loading capacity



GCL230



GCL820



Part No.	W x D x H (mm)	For Cylinder Size (mm)	Weight (kg)
GCL230	510 x 280 x 100	216 ~ 230 Dia.	3.2
GCL820	545 x 280 x 90	127 ~ 240 Dia.	3.6

## ADJUSTA GAS CYLINDER STORAGE HOOK

The new and improved gas hook has adjustable opening for fitting various cylinders shoulder diameters. Adjustment screws keep the hook secure.

Hooks install and uninstall around the valve and hoses from the side - no need to remove valves or hoses.

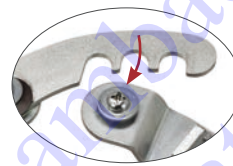

Adjustable Opening



Part No.	Dimension (mm)	Weight (kg)
GCH160	243 x 216 x 157	1.0



## CYLINDER CART

This new cylinder cart allows you to safely lift, move, place and store heavy cylinders. The sliding Stainless Steel Keeper Bar holds the cylinder securely in place without the use of chains or straps.

Lift cylinders for placement on an elevated platform, such as a welding cart or pallet up to 178 mm high. Two 3" rear locking wheels provide easy movement + stable storage.

Rugged round steel tube welded construction for strength and durability, with powder coated finish.

Part No.	Load Capacity (kg)	For Cylinder Size (mm)	Weight (kg)
GCC210	180	216 ~ 230 Dia.	24



# NOMAD™ Economy Welding Table & Accessories

Very Affordable. Fully Adjustable. Easily Movable.

NEW ITEM

The Nomad Economy Welding Table is engineered to provide a safe, transportable, affordable, and versatile welding surface.

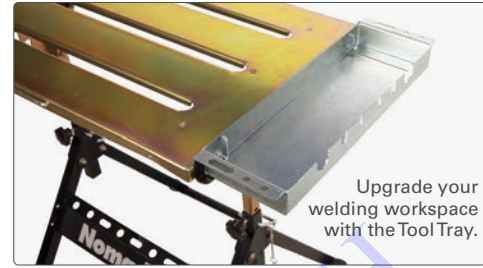
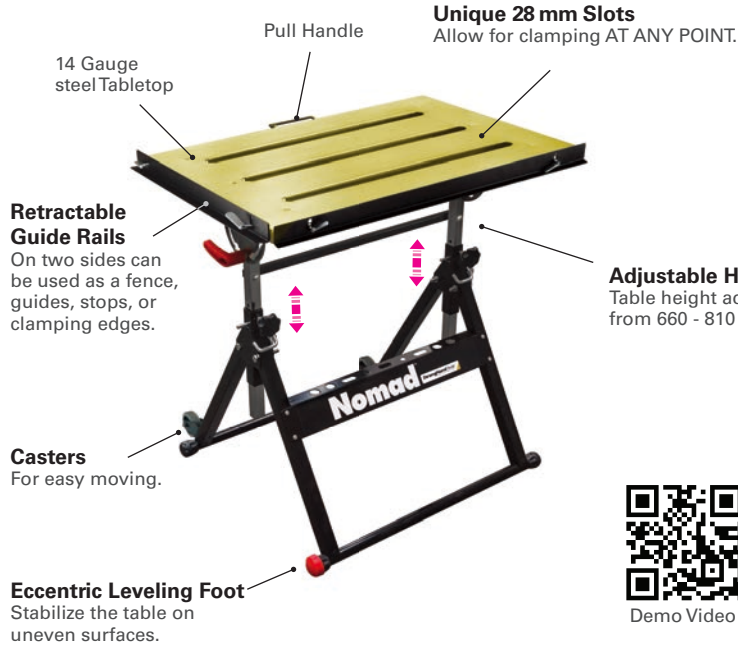

Part No.	Dimensions (mm)	Weight (kg)
TS3020-12	496 x 150 x 50	2.2

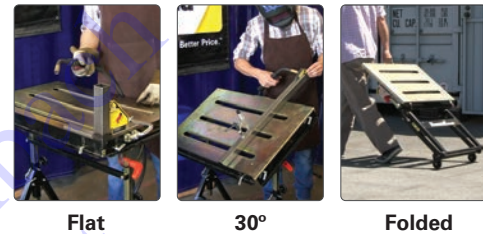

Part No.	Tabletop Size (mm)	Table Height Range (mm)	Slot in Tabletop (mm)	Table Positions	Load Capacity (kg)	Weight (kg)
TS3020	760 W x 510 L	660 - 810	28	0°, 30°, Folded	160	20

## NOMAD™ ECONOMY TOOL KIT

The Nomad Economy Tool Kit is ideal for clamping and positioning stock on the Nomad Table.

Part No.	Kit includes	Weight (kg)
TSK104M	2x MagSpring Clamp UBV45M 1x Multi-Angle Magnet MS346C 1x Mini Magnet MS346A 2x Magnetic V-Pad XDV4	1.8



## NOMAD™ CONNECTOR PLATE

Need more tabletop workspace? Use the Nomad™ Connector Plate to join two Nomad Tables together to create a 2.3 m long workstation!

Clamp and work on larger projects, or multiple projects with the fully adjustable work surface! There are thru holes on all four sides of the Connector Plate for multiple mounting options.



TSL30 (Includes all mounting screws)

Part No.	Weight (kg)
TSL30	7.4

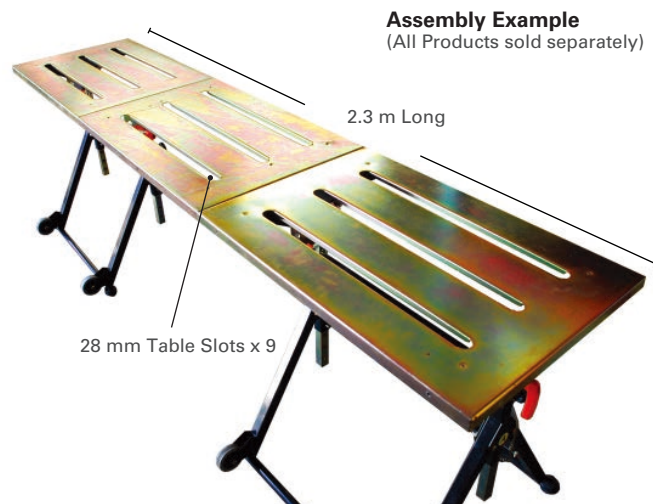

# Mobile, Modular Sawhorse Workstation

Mobile Work Stands with Pro-Level Fixturing, Anywhere You Work!



## Standard Duty, Foldable Sawhorse Legs

- Professional-Grade Surface:**  
 16 mm thick nitrid-coated plate offers durability & longevity in demanding environments.
- Universal Compatibility:**  
 Designed to mount easily to most workbenches, giving you a flexible upgrade without replacing your existing setup.
- Precision Clamping:**  
 Compatible with standard Inserta clamps, pins, & fixtures, so your tools go wherever you do.
- Compact, Efficient Design:**  
 Slim 150 mm width is ideal for tasks that require narrow but sturdy support without taking over your entire bench.
- Made for Modularity:**  
 Works as a standalone work surface or as part of a custom workstation layout.



TSB915-F1



Part No.	Dimension (mm)	Max. Capacity (kg)	Weight (kg)
TSB915	900 x 150 x 125.6	270	22.0
TSB915-F1	900 x 430 x 850	135	27.0
TSB915-K1	900 x 430 x 850	135	30.5

NEW ITEM

## NOMAD Table Legs

When the job moves, your gear should too. With durable surfaces, clamp-ready plates, & rock-solid support, these tools keep your workflow sharp & efficient, even off the grid.

- Professional-Grade Surface:**  
 16 mm thick nitrid-coated plate offers durability & longevity in demanding environments.
- Precision Clamping:**  
 Compatible with standard Inserta clamps, pins, & fixtures, so your tools go wherever you do.
- Fully Adjustable Support:**  
 Angle & height adjustable. 3 preset tilt positions: flat, 30°, 85°. Height Adjust Setting **H: 760 / 790 / 820 / 860 / 900 mm**.  
 Portable & Compact: Folds easily for quick setup, & storage.



TSB915-NF1

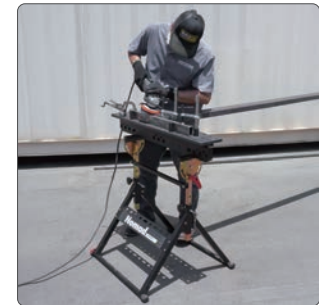

Part No.	Dimension (mm)	Max. Capacity (kg)	Weight (kg)
TSB915-NF1	900 x 650 x H	150	36.0
TSB915-NK1	900 x 650 x H	150	39.5

NEW ITEM

## Parts & Accessories

There are 4 optional packages for you to choose.

- TSB915-K1 = TSB915-F1 + TSBM-A
- TSB915-NK1 = TSB915-NF1 + TSBM-A



TFSH36



TSBM-A



TSJ280



TSB366-NAP

Part No.	Description	Weight (kg)
TFSH36	Foldable Sawhorse Legs, Light Duty	4.3
TSJ280	Sawhorse Joining Kit	0.5
TSB366-NAP	Nomad Adapter For SH Plate	1.0
TSBM-A	Clamping Kit w/ Tool Pouch, 13 pc.	3.5

NEW ITEM

# 12-sided Circular Plate + Scout Tripod, Work Stand

Perfect for tight spaces, job psites, or workshops where flexibility is key.

NEW ITEM

## Mobile Work Stands with Pro-Level Fixturing, Anywhere You Work.

- Professional-Grade Surface:**  
 16 mm thick nitrid-coated plate offers durability & longevity in demanding environments.
- 16 mm System Compatible:**  
 16 mm fixturing holes in a 50 x 50 mm grid, compatible with all 16 mm BuildPro modular tooling.
- Precision Clamping:**  
 Compatible with standard Inserta clamps, pins, and fixtures, so your tools go wherever you do.
- Compact, Efficient Design:**  
 At its core is a 12-sided circular plate (350 mm diameter) made from durable steel.
- Made for Modularity:**  
 Works as a standalone work surface or as part of a custom workstation layout.

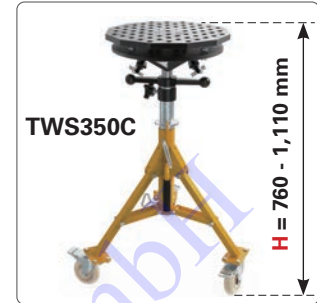

- TWS350-KN1 = TWS350-FN1 + TSBM-A
- TWS350-KF1 = TWS350 + TSBM-A
- TWS350-KC1 = TWS350C + TSBM-A



Part No.	Dimension (mm)	Max. Capacity (kg)	Weight (kg)
TWS350-FN1	350 x 350 x 130	135	19.5
TWS350	530 x 530 x H	1,100	32.5
TWS350C	530 x 530 x H	400	33.7
TWS350-KN1	350 x 350 x 130	135	23.0
TWS350-KF1	530 x 530 x H	1,100	36.0
TWS350-KC1	530 x 530 x H	400	37.2

NEW ITEM

## Parts & Accessories

There are 4 optional packages for you to choose.  
 Mobile, Adjustable Support for your workpieces.

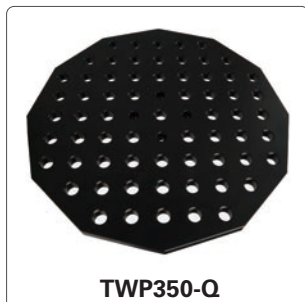

Part No.	Description	Weight (kg)
PTS1108F	Fixed Tripod, Foldable Base Only	13.0
PTS1108C	Caster Tripod, Foldable Base Only	14.2
TWP350-Q	350 mm Plate only, 15.88 mm Thickness	10.5
TSBM-A	Clamping Kit w/ Tool Pouch, 13 pc.	3.5

# Modular Tube & Pipe Notcher

Notch tubes and pipes at the accurate angle and length.



Mounting your Notcher on the: BuildPro®, Rhino Cart®, or BuildPro® Fixturing Plates allows for quick and accurate setups when notching multiple parts.

Notch 25 mm - 63.5 mm OD pipes or square tubes at any angle, or offcenter. Position the two V-Blocks and clamp as needed.

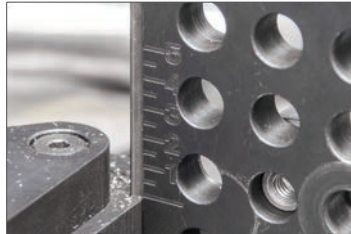

Height Setting Scale

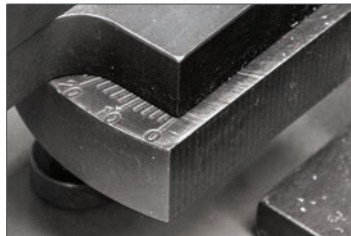

Angle Setting Scale



In the examples below, the Notcher is used to notch workpieces as needed to fit seamlessly into a final assembly:



45°



Compound Angles



90°

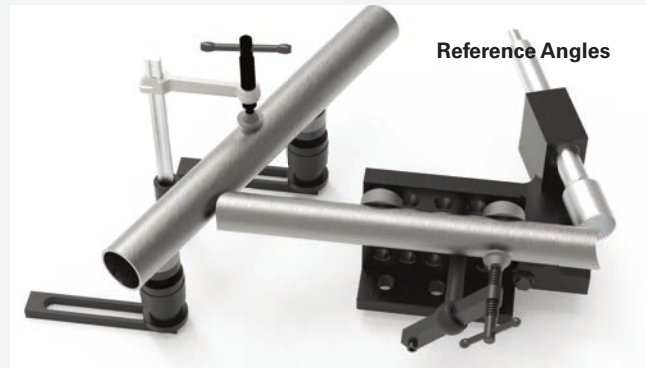

Reference Angles

**Strong Hand Tools offers different styles of welding tables to provide a solution for every need and workspace. All table systems have matching accessory kits to provide faster fixturing, consistent results, and greater productivity.**



[www.BuildProTables.com](http://www.BuildProTables.com)

**The professional BuildPro® Welding Tables are setting a new standard in price and performance.**

The BuildPro's modular design gives you the flexibility to adapt to each new project easily. You'll work more safely and efficiently, so you can increase both your productivity and quality of work.

- CNC machined 16 mm holes in a 50 mm grid pattern for locating, positioning and holding your fixture.
- REVERSIBLE Plates can be reconfigured to extend the width of the table for larger projects.

U.S. PAT. 8065967



*In-stock for immediate delivery.  
Contact us for complete catalog.*



[www.Alpha28Tables.com](http://www.Alpha28Tables.com)

Expand your capabilities in fixturing heavy duty, complex, or oversized weldments for precision welding and fabrication.

- Individual positionable, reversible table plates
- HV550 - HV750 Tabletop Hardness
- QPQ Nitriding Treatment



[www.rhino-cart.com](http://www.rhino-cart.com)

The Rhino Cart® Mobile Fixturing Station is a turnkey system for fixturing and clamping in welding and fabrication.

- Reversible, flat, nitrided (heat treated) tabletops for accuracy in all of your setups. Three sizes are available.
- The Rhino Cart® Tables are compatible with the Clamps and Components in the BuildPro® Welding Table product line.

U.S. PAT. 9896117



Learn more about our other clamping and fabrication product lines.



## FixturePoint™

Jig & Fixture Table

[www.BuildProTables.com](http://www.BuildProTables.com)

The economy priced FixturePoint™ Tables are ideal for the setup of 2D frames and other basic fixtures.

The lightweight 4 mm tabletop plate can be set at 30°, 45°, and 65° to provide comfort and extra working space for small projects on the side. Easily moves around the shop!

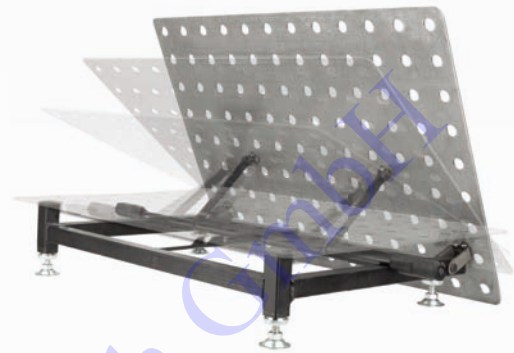

Toggle Clamps

[www.goodhandinc.com](http://www.goodhandinc.com)

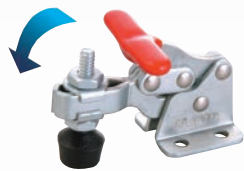

**Vertical Handle**  
Hold Down Action



**Horizontal Handle**  
Hold Down Action

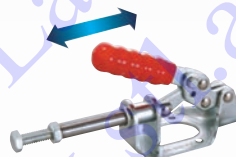

**Push/Pull**  
Straight Line Action



**Latch Type**  
Pull Action



Machine Parts & Tooling Components.

[www.valtrainc.com](http://www.valtrainc.com)



Handwheels



Adjustable Handles



Crank Handles



Rotary T-Slot Nuts



Leveling Pads



Rotary T-Slot Bolts



Plain Eyebolts



## USA Headquarters

8750 Pioneer Blvd, Santa Fe Springs, CA 90670  
Tel: 562-949-8625  
Fax: 562-949-4875  
sales@stronghandtools.com

## Texas Distribution Warehouse

1016 W Harris Rd, Arlington TX 76001  
Tel: 562-949-8625  
Fax: 562-949-4875  
sales@stronghandtools.com

## Europe

Tomáše Bati 1075, 674 01 Třebíč, Czech Republic  
Tel: +420 607 088 465  
sales@stronghand.eu

## Asia

No. 605 Huabo Rd, Huating Town, Jiading District,  
Shanghai, China 201816  
Tel: +86-21-59103639  
Fax: +86-21-59102951  
asiasales@stronghandtools.com

**2025 September Second Print.**

©2025



Visit Home Page



Download Catalogs



Find Distributors



CATALOG-SH-M\_2025\_V2